

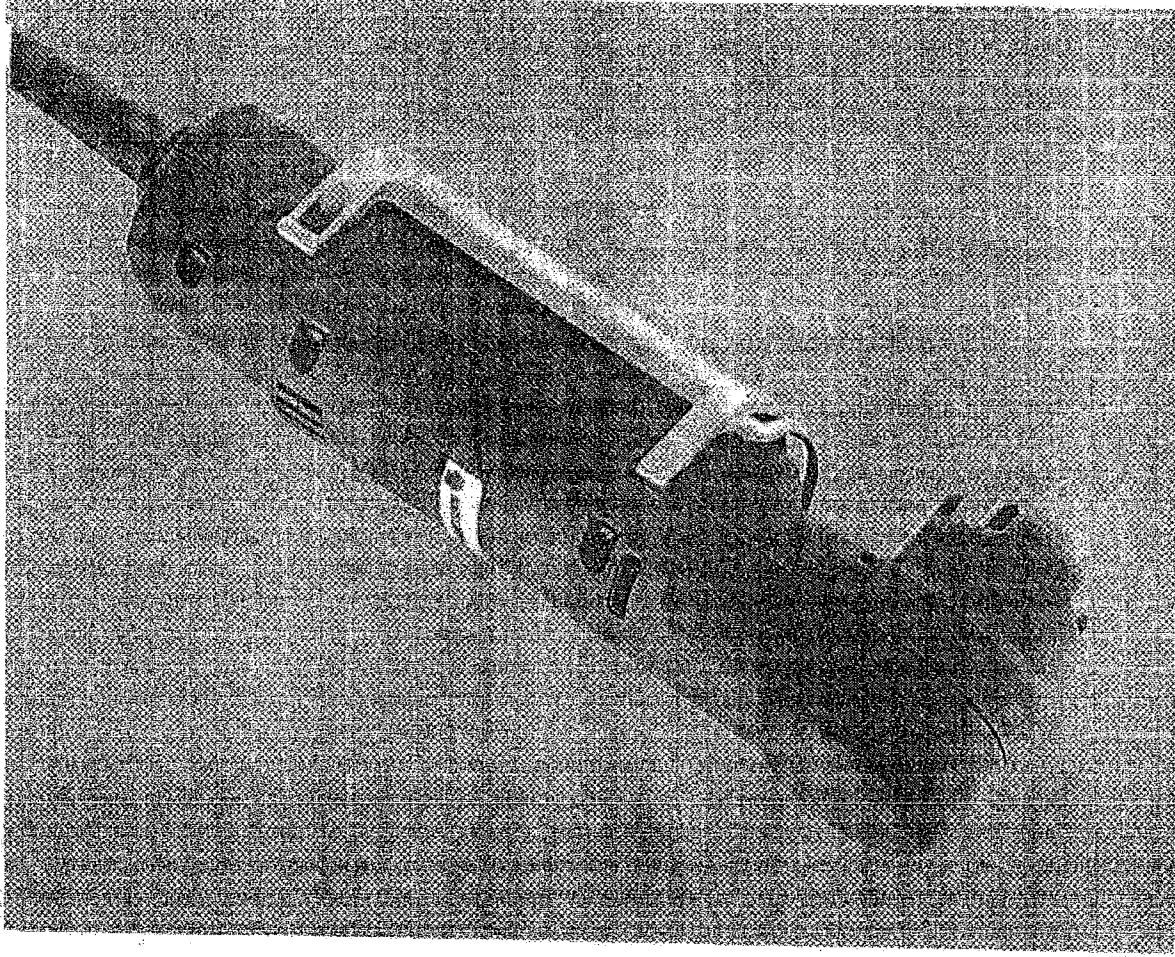

BLACK&DECKER®



Instruction Manual

1/4" & 3/8" Shorty® Drills

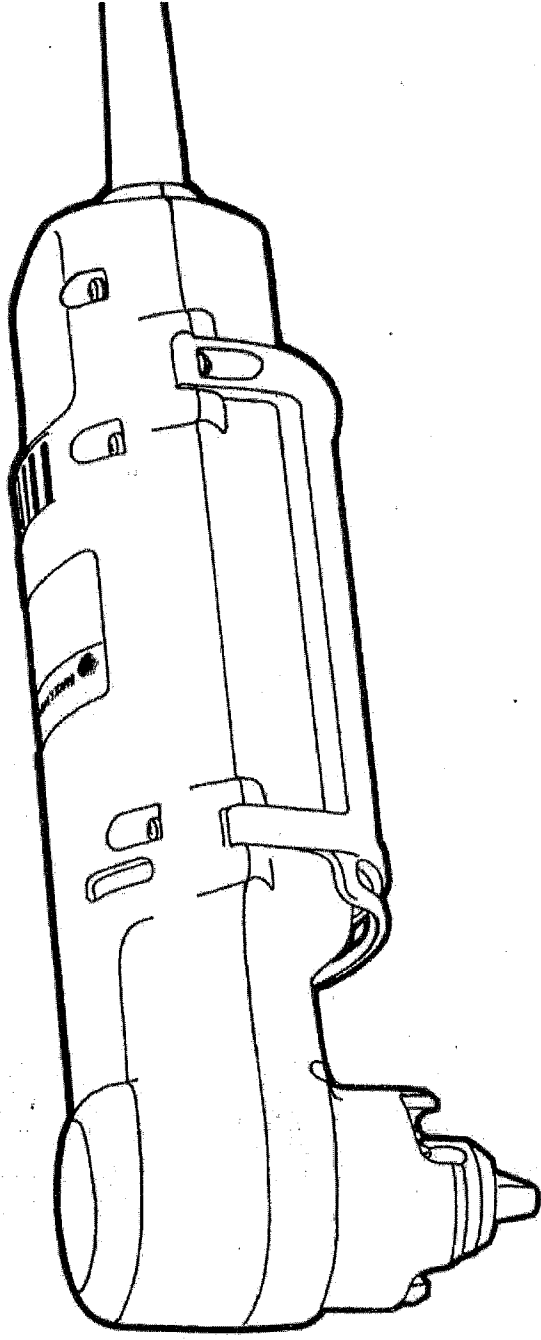

Thanks For Buying a Black & Decker Drill.

Your new Shorty® drill is an excellent choice for real value.

Engineered to Black & Decker's exacting standards for quality, your drill will perform like the true professional it is.

Small enough to get into the really tight places, it's loaded with the kind of power you need to do a first rate job.

With the proper accessories listed in this manual, you can drill in steel, wood, ceramics, plastics and

compositions with ease and accuracy. You can also buff, polish, grind and wire brush.

Please take a few minutes to read this informative instruction manual. Pay particular attention to the safety rules we've provided for your protection.

Don't forget to send in your owner's registration card.

**THANKS AGAIN FOR BUYING
BLACK & DECKER!**



BLACK & DECKER®

Important Safety Instructions

WARNING: When using electric tools, basic safety precautions should always be followed to reduce risk of fire, electric shock, and personal injury, including the following:

READ ALL INSTRUCTIONS

Double Insulation

Double insulated tools are constructed throughout with two separate layers of electrical insulation or one double thickness of insulation between you and the tool's electrical system. Tools built with this insulation system are not intended to be grounded. As a result, your tool is equipped with a two prong plug which permits you to use extension cords without concern for maintaining a ground connection.

NOTE: Double insulation does not take the place of normal safety precautions when operating this tool. The insulation system is for added protection against injury resulting from a possible electrical insulation failure within the tool.

CAUTION: WHEN SERVICING USE ONLY IDENTICAL REPLACEMENT PARTS. Repair or replace damaged cords.

Polarized Plugs

Polarized plugs (one blade is wider than the other) are used on equipment to reduce the risk of electric shock. When provided, this plug will fit in the polarized outlet only one way. If the plug does not fit fully into the outlet, reverse the plug. If it still does not fit, contact a qualified electrician to install the proper outlet. Do not change the plug in any way.

Safety Instructions For All Tools

- **KEEP WORK AREA CLEAN.** Cluttered areas and benches invite injuries.
- **CONSIDER WORK AREA ENVIRONMENT.** Don't expose power tools to rain. Don't use power tools in damp or wet locations. Keep work area well lit. Do not use tool in presence of flammable liquids or gases.
- **GUARD AGAINST ELECTRIC SHOCK.** Prevent body contact with grounded surfaces. For example; pipes, radiators, ranges, and refrigerator enclosures.
- **KEEP CHILDREN AWAY.** Do not let visitors contact tool or extension cord. All visitors should be kept away from work area.
- **STORE IDLE TOOLS.** When not in use, tools should be stored in dry, and high or locked-up place — out of reach of children.
- **DON'T FORCE TOOL.** It will do the job better and safer at the rate for which it was intended.
- **USE RIGHT TOOL.** Don't force small tool or attachment to do the job of a heavy-duty tool. Don't use tool for purpose not intended.
- **DRESS PROPERLY.** Do not wear loose clothing or jewelry. They can be caught in moving parts. Rubber gloves and non-skid footwear are recommended when working outdoors. Wear protective hair covering to contain long hair.
- **USE SAFETY GLASSES.** Also use face or dust mask if operation is dusty.
- **DON'T ABUSE CORD.** Never carry tool by cord or yank it to disconnect from receptacle. Keep cord from heat, oil, and sharp edges.
- **SECURE WORK.** Use clamps or a vise to hold work. It's safer than using your hand and it frees both hands to operate tool.
- **DON'T OVERREACH.** Keep proper footing and balance at all times.
- **MAINTAIN TOOLS WITH CARE.** Keep tools sharp and clean for better and safer performance. Follow instructions for lubricating and changing accessories. Inspect tool cords periodically and if damaged, have repaired by authorized service facility. Inspect extension cords periodically and replace if damaged. Keep handles dry, clean, and free from oil and grease.
- **DISCONNECT OR LOCK OFF TOOLS** when not in use, before servicing, and when changing accessories, such as blades, bits, cutters.
- **REMOVE ADJUSTING KEYS AND WRENCHES.** Form habit of checking to see that keys and adjusting wrenches are removed from tool before turning it on.
- **AVOID UNINTENTIONAL STARTING.** Don't carry tool with finger on switch. Be sure switch is off when plugging in.
- **EXTENSION CORDS.** Make sure your extension cord is in good condition. When using an extension cord, be sure to use one heavy enough to carry the current your product will draw. An undersized cord will cause a drop in line voltage resulting in loss of power and overheating. The following table shows the correct size to use depending on cord length and nameplate amperage rating. If in doubt, use the next heavier gage. The smaller the gage number, the heavier the cord.
- **OUTDOOR USE EXTENSION CORDS.** When tool is used outdoors, use only extension cords intended for use outdoors and so marked.
- **STAY ALERT.** Watch what you are doing. Use common sense. Do not operate tool when you are tired.
- **CHECK DAMAGED PARTS.** Before further use of the tool, a guard or other part that is damaged should be carefully checked to determine that it will operate properly and perform its intended function. Check for alignment of

Volts	Minimum Gage for Cord Sets		
	0-25	26-50	51-100
120V	16	14	12
240V	16	14	12
Amperage Rating		AWG	
More Than	Not more Than		
0 - 6	18	16	14
6 - 10	18	16	14
10 - 12	16	16	14
12 - 16	14	12	Not Recommended

moving parts, binding of moving parts, breakage of parts, mounting, and any other conditions that may affect its operation. A guard or other part that is damaged should be properly repaired or replaced by an authorized service center unless otherwise indicated elsewhere in this instruction manual. Have defective switches replaced by authorized service center. Do not use tool if switch does not turn it on and off.

- **CAUTION:** When drilling or driving into walls, floors or wherever live electrical wires may be encountered, **DO NOT TOUCH ANY METAL PARTS OF THE TOOL!** Hold the tool only by insulated grasping surfaces to prevent electric shock if you drill or drive into a live wire.

SAVE THESE INSTRUCTIONS

Motor Brushes

Your Drill uses the B & D "Checkpoint" brush system. The tool will stop when the brushes wear out (down to about 3/16" long). This prevents damage to the motor.

Switch

To turn the tool ON, depress the paddle switch that runs the length of the tool, as shown in Figure 1. To turn the tool OFF, release the paddle.

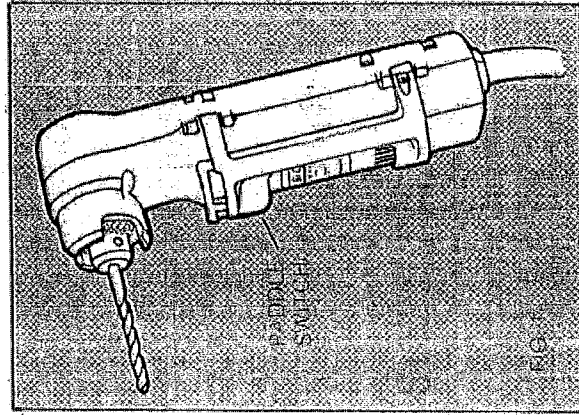

Chuck

Open chuck jaws by aligning hole in chuck with an opening in the chuck guard, and insert the chuck key through the opening and into the chuck (Fig. 2). Insert shank of bit about 3/8" into chuck. It's important to tighten chuck with all three holes. To release bit, turn key counter-clockwise in just one hole.

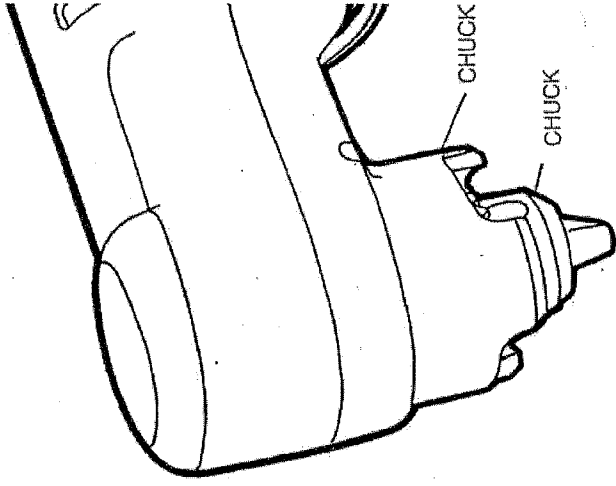
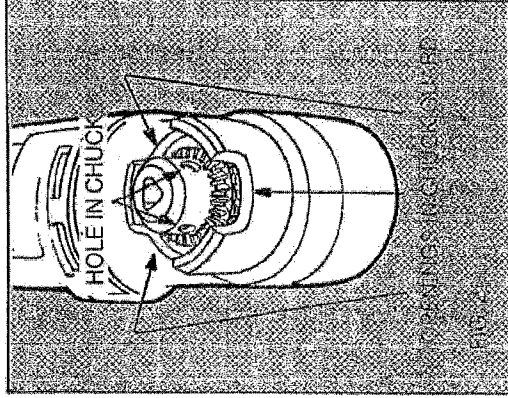

Operation

DRILLING

1. Always unplug the Drill when attaching or changing bits or accessories.
2. Use sharp drill bits only. For WOOD, use twist drill bits, spade bits, power auger bits, or hole saws. For METAL, use high-speed steel twist drill bits or hole saws. For MASONRY, such as brick, cement, cinder block, etc., use carbide-tipped bits.
3. Be sure the material to be drilled is anchored or clamped firmly. If drilling thin material, use a wood "back-up" block to prevent damage to the material.
4. Always apply pressure in a straight line with the bit. Use enough pressure to keep drill biting, but do not push hard enough to stall the motor or deflect the bit.
5. Hold drill firmly to control its twisting action.
6. IF DRILL STALLS, it is usually because it is being overloaded or improperly used. **RELEASE PADDLE SWITCH IMMEDIATELY**, remove drill bit from work, and determine cause of

stalling. **DO NOT CLICK SWITCH OFF AND ON IN AN ATTEMPT TO START A STALLED DRILL — THIS CAN DAMAGE THE DRILL.**

7. To minimize stalling or breaking through the material, reduce pressure on drill and ease the bit through the last fractional part of the hole.
8. Keep the motor running when pulling the bit back out of a drilled hole. This will help prevent jamming.
9. For optimum control and comfort, the drill may be grasped in one of the following illustrated manners: Around the "neck" of the drill using one or two fingers to operate the paddle switch as in FIG. 3, in an inverted position with the heel of the hand pushing on the head of the drill and one or two fingers on the paddle switch as in FIG. 4, or one hand and operating the paddle switch with the other hand holding the back end of the drill as in FIG. 5.

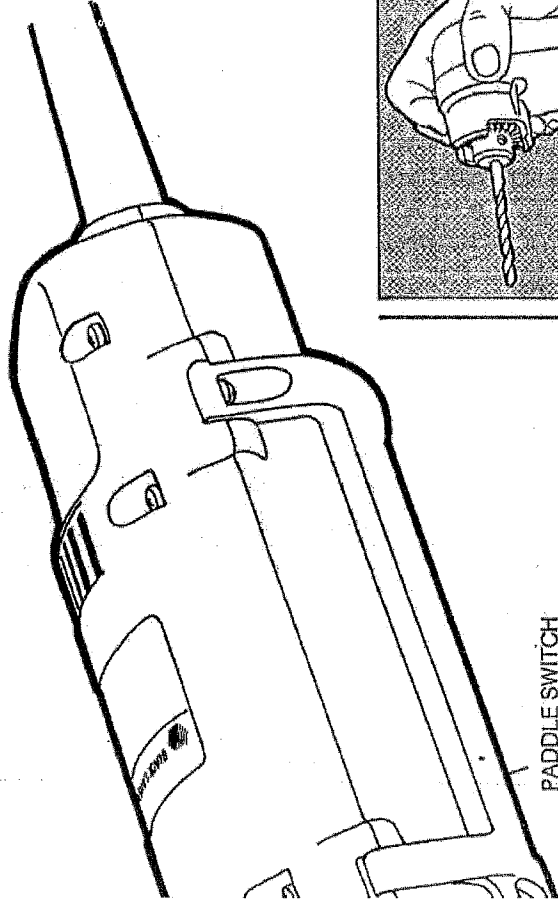

Chuck Key Holder

1. Push double-hole end of Holder through slot in other end of Holder (Figure A).
2. Slip loop over electric plug and draw loop tight around cord (Figure B).
3. Push ends of Chuck Key Handle through two holes in end of Holder (Figure C).

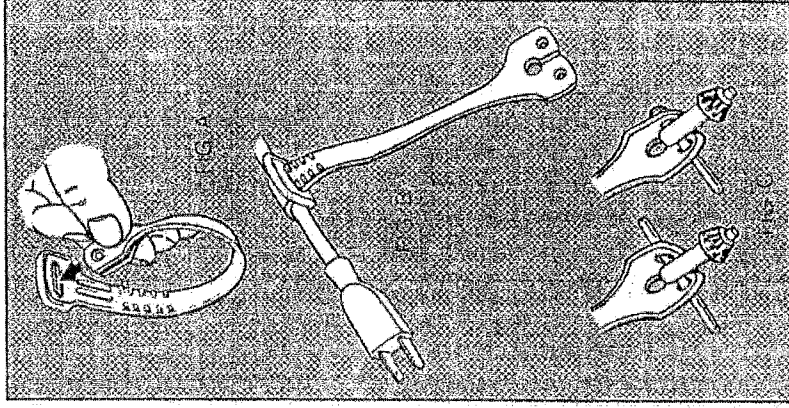

Chuck Removal

Insert straight end of chuck key handle into chuck as shown below. Using a wooden mallet or similar object, strike key sharply in a counterclockwise direction. This will loosen chuck so that it can be unscrewed by hand.

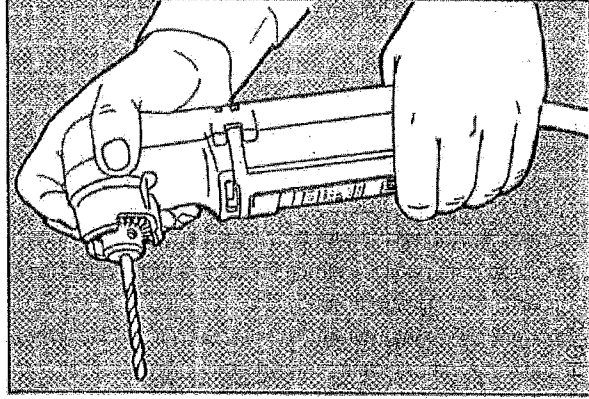
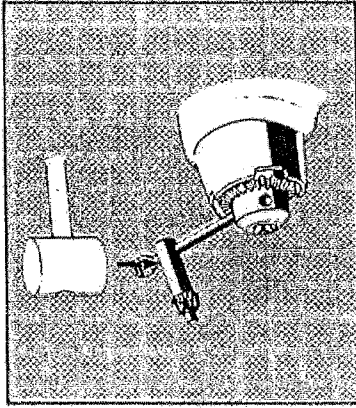

Drilling In Metal

Use a cutting lubricant when drilling metals. The exceptions are cast iron and brass which should be drilled dry. The cutting lubricants that work best are sulfurized cutting oil or lard oil; bacon-grease will also serve the purpose.

Drilling In Wood

Holes in wood can be made with the same twist drills used for metal. These bits may overheat unless pulled out frequently to clear chips from the flutes. For larger holes, use Power Drill Wood Bits. Work that is apt to splinter should be backed up with a block of wood.

Drilling In Masonry

Use carbide tipped masonry bits at low speeds. Keep even force on the drill but not so much that you crack the brittle materials. A smooth, even flow of dust indicates the proper drilling rate.

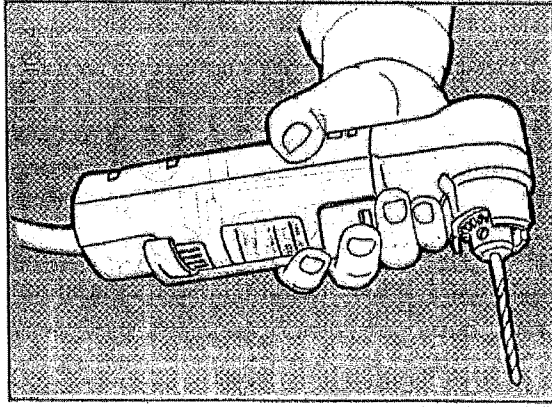
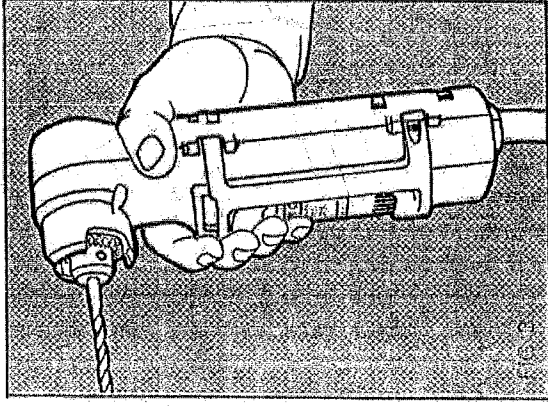

Maximum Drilling Capacities

DRILL SPEED (RPM)	1200	1200	2000
CHUCK SIZE	3/8"	1/4"	3/8"
TWIST BITS IN METAL	3/8"	1/4"	3/8"
FLAT BORING BITS IN WOOD	1 1/4"	3/4"	3/4"
CARBIDE TIPPED BITS IN MASONRY	9/16"	1/2"	1/2"
HOLE SAWS IN WOOD OR METAL	1 1/4"	1"	1"

WIRE WHEEL BRUSHES	4" Dia. Max.
WIRE CUP BRUSHES	3" Dia. Max.
BUFFING WHEELS	3" Dia. Max.
RUBBER BACKING PADS	4 3/4" Dia. Max.

ACCESSORY MUST BE RATED FOR USE AT SPEED EQUAL TO OR HIGHER THAN NAMEPLATE R.P.M. OF TOOL

Carbon Removing Brushes

Made of tempered-steel wire; used with 3/4" drills to remove rust and scale from metals. Leaves a burnished surface.

- A. Heavy-duty solid wire-filled brush.
- B. Side-flare brush for close corner work.
- C. Hollow-core, flare-bottom brush. Small cleaning brush. (Not shown.)

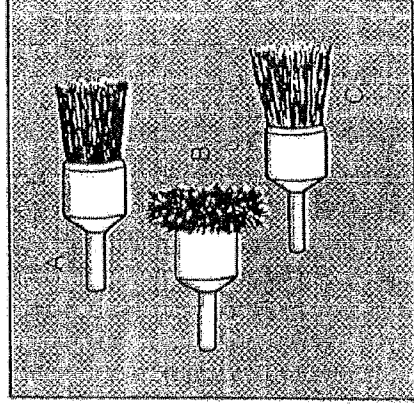

High-Speed Hole Saws use with Mandrels

SAW OUTSIDE DIAMETER	FOR CONDUIT SIZES	FOR PIPE TAP SIZES
5/8"	3/4"	3/4" Hole Saw has built-in Mandrel; no separate Mandrel supplied
3/4"	3/4"	
7/8"	1/2"	3/4"
1 5/16"		
1"		
1 1/16"		
1 3/8"	3/4"	1"
1 3/16"		
1 1/2"		

Round-Shank Masonry Bits

These bits are carbide-tipped for top performance and extra-long life in most masonry-drilling applications.

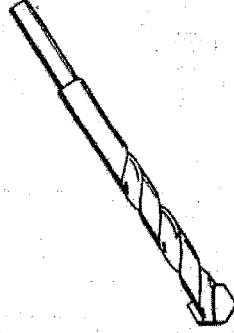

BIT DIAMETER (IN.)	USABLE DRILLING DEPTH (IN.)	SHANK DIAMETER (IN.)
3/16"	1 1/2"	3/16"
1/4"	2"	1/4"
5/16"	2 1/4"	1/4"
3/8"	2 1/2"	1/4"
1/2"	2 1/2"	1/4"
9/16"	4 1/4"	1/4"

3" Wire Cup Brush

Use in cleaning and removing rust, scale, old paint. (Straight chuck shank). Maximum safe RPM—5,000.

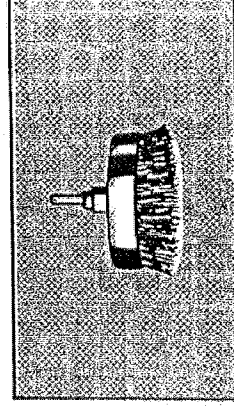

Heavy-Duty Tool Box

13" x 8 1/2" x 6 3/4"

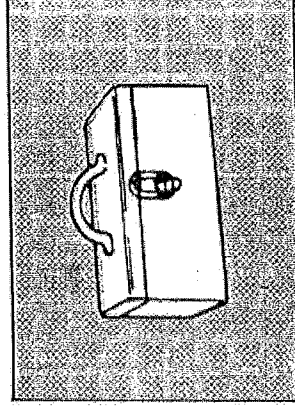

Drill Stop

Capacity $\frac{1}{4}$ " to $\frac{1}{2}$ " Governs drilling depth. Drill Stop.

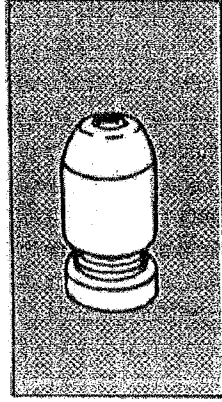

Wire Wheel Brushes

Use in cleaning and removing rust, scale, old paint. 4" Fine Brush, crimped; Maximum safe RPM—4,500
4" Coarse Brush, crimped; Maximum safe RPM—4,500

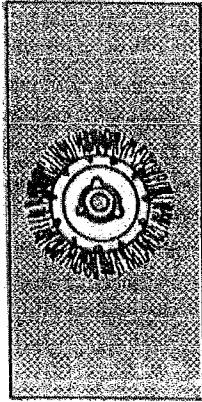

Wheel Arbors

Fit $\frac{1}{4}$ " to $\frac{1}{2}$ " Drills. Carry wire wheel brushes and buffing wheels. $\frac{1}{4}$ " Arbor ($\frac{1}{2}$ " dia., $\frac{1}{4}$ " shank).

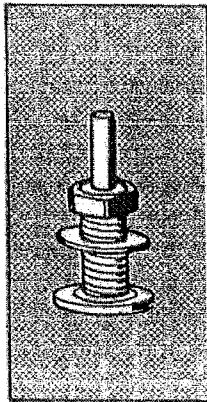

Buffing Wheels

Use with $\frac{1}{4}$ " to $\frac{1}{2}$ " Drills and Wheel Arbors. 3" x $\frac{3}{8}$ " x $\frac{1}{2}$ " Cotton Buff.

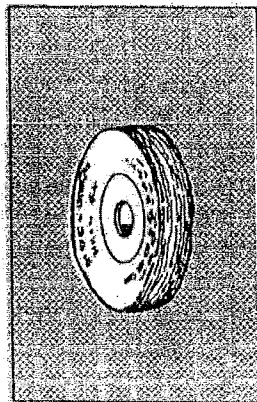

Rubber Backing Pad

Fit $\frac{1}{4}$ " to $\frac{1}{2}$ " Drills. $4\frac{1}{2}$ " Rubber Backing Pad with plain shank.

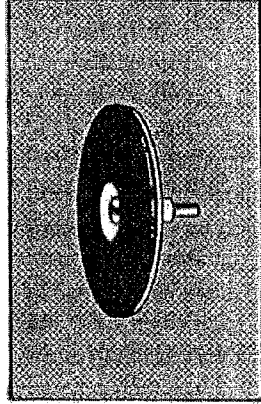

Lubrication (All Drills)

All ball bearings used are factory lubricated to last the life of the bearings. All needle bearings used received their lubrication from the grease in the gear case. Clean and re-lubricate gear case yearly or whenever servicing requires the gear case to be removed. Use type and quantity of grease shown on Parts Bulletin packed with your tool.

Drill Accessories

The accessories listed in this manual are available at extra cost from your local dealer or Black & Decker Service Center. A complete listing of service centers is included with your tool.

If you need assistance in locating any accessory, please contact: Black & Decker (U.S.) Inc., Consumer Service Department, 626 Hanover Pike, P.O. Box 618, Hampstead, MD 21074-0618.

Recommended accessories for your Drill are shown in this manual (CAUTION: The use of any other accessory or attachment might be hazardous.)

Notes

Warranty

Black & Decker (U.S.) Inc. warrants this product for one year from date of purchase. We will repair without charge, any defects due to faulty material or workmanship. Please return the complete unit, transportation prepaid, to any Black & Decker Service Center or Authorized Service Station listed under "Tools Electric" in the yellow pages. This warranty does not apply to accessories or damage caused where repairs have been made or attempted by others.

Every Black & Decker tool is of the highest quality. If you wish to contact us regarding this product, please call toll free between 8:00 a.m. and 8:00 p.m. ET, seven days a week.
1-800-762-6672



See 'Tools-Electric'
-Yellow Pages-
for Service & Sales



BLACK&DECKER®



1065/1165

Print
(JUN95-CD-10) Copyright © 1992, 1993, 1995 Bla
BLACK & DECKER (U.S.) INC., 701 E. Joppa Road, Towson, MD 2