

PACCAR

Engine Aftertreatment Systems

Operator's Manual

2017 Emissions

Safety

1

Introduction

2

Maintenance

3

Information

4

© 2017 PACCAR Inc. - All Rights Reserved

This manual illustrates and describes the operation of features or equipment which may be either standard or optional on this vehicle. This manual may also include a description of features and equipment which are no longer available or were not ordered on this vehicle. Please disregard any illustrations or descriptions relating to features or equipment which are not on this vehicle. PACCAR reserves the right to discontinue, change specifications, or change the design of its vehicles at any time without notice and without incurring any obligation. The information contained in this manual is proprietary to PACCAR. Reproduction, in whole or in part, by any means is strictly prohibited without prior written authorization from PACCAR Inc.

Chapter 1 | SAFETY

In this Chapter:

Using this Manual.....	7
Safety Alerts.....	7
Illustrations.....	8

Using this Manual

Please take the time to get acquainted with your vehicle by reading this Operator's Manual. We recommend that you read and understand this manual from beginning to end before you operate this equipment. This manual contains useful information for the safe and efficient operation of this equipment. It also provides service information, with an outline for performing safety checks and basic preventive maintenance inspections. We have tried to present the information you'll need to learn about functions, controls, and operation—and to present it as clearly as possible. We hope you'll find this manual easy to use. There will be times when you need to take this manual out of the glovebox. When you do, please be sure to return it when you are finished using it. That way it will be there when you need it the next time or when you pass the vehicle on to the next user.

	NOTE
<p>After you've read this manual, it should be stored in the cab for convenient reference and remain with this truck when sold.</p>	

Your vehicle may not have all the features or options mentioned in this manual. Therefore, you should pay careful attention to the instructions that pertain to just your vehicle. In addition, if your vehicle is equipped with special equipment or options not discussed in this manual, consult your dealer or the manufacturer of the equipment. There are several tools built into this manual to help you find what you need quickly and easily. First is the Quick Table of Contents. Located at the front of the manual, this lists the main subjects covered and gives section numbers where you can find these subjects. Use the Quick Table of Contents to find information on a large subject like "Maintenance." Cross-referenced citations also help you get the information you need. If some other part of the manual contains further information on the subject you are reading about, we'll

indicate that in a cross-reference like this: (See [Safety Alerts](#) on page 7). You won't have to go searching for more information. Finally you'll find a helpful Subject Index. It's in the back of the manual and alphabetically lists the subjects covered. So if you want information on brakes, for example, just look under Brake in the Subject Index. You'll find all the pages listed where brakes or braking are discussed. All information contained in this manual is based on the latest production information available at the time of publication. Kenworth Truck Company Peterbilt Motors Company reserves the right to make changes at any time without notice.

Safety Alerts

Please read and follow all of the safety alerts contained in this manual. They are there for your protection and information. These alerts can help you avoid injury to yourself, your passengers and help prevent costly damage to the vehicle. Safety alerts are highlighted by safety alert symbols and signal words such as "WARNING", "CAUTION", or "NOTE". Please DO NOT ignore any of these alerts.

Warnings

The safety message following this symbol and signal word provides a warning against operating procedures which could cause death or injury. They could also cause equipment or property damage. The alert will identify the hazard, how to avoid it and the probable consequence of not avoiding the hazard.

**WARNING**

Hot engine oil can be dangerous. You could be burned. Let the engine oil cool down before changing it. Failure to comply may result in death, personal injury, equipment or property damage.

Cautions

The safety message following this symbol and signal word provides a caution against

operating procedures which could cause equipment or property damage. The alert will identify the hazard, how to avoid it, and the probable consequence of not avoiding the hazard.

**CAUTION**

Continuing to operate your vehicle with insufficient oil pressure will cause serious engine damage. Failure to comply may result in equipment or property damage.

Notes

The message following this symbol and signal word provides important information that is not safety related but should be followed. The alert will highlight things that may not be obvious and is useful to your efficient operation of the vehicle.

**NOTE**

Pumping the accelerator will not assist in starting the engine.

Illustrations

Some of the illustrations throughout this manual are generic and will NOT look exactly like the engine or parts used in your application. The illustrations can contain symbols to indicate an action required and/or an acceptable or NOT acceptable condition. The illustrations are intended to show repair or replacement procedures. The procedure will be the same for all applications, although the illustration may differ.

Chapter 2 | INTRODUCTION

In this Chapter:

Vehicle Emissions Controls.....	12
Lamps.....	12
What is a Diesel Particulate Filter?.....	14
Functionality / Notification Information.....	14
Extended Idling.....	15
Warning Symbols Quick Reference.....	15
Notification of High Exhaust System Temperature.....	17
Notification Regeneration is Required.....	18
Controlling Regeneration Process.....	19
How to Enable an Automatic Regeneration of the DPF.....	21
How to Start a Parked Regeneration.....	22
Stop an Automatic or Parked Regeneration.....	23
What is a Selective Catalyt Reduction System?.....	24
DEF Gauge.....	24

Why is the DEF Warning Light on?..... 25
Functionality / Notification Information..... 26

Vehicle Emissions Controls

This vehicle has an exhaust Aftertreatment System (ATS), to control vehicle exhaust emissions. The exhaust Aftertreatment system consist of a Diesel Particulate Filter (DPF), Selective Catalyst Reduction (SCR), Regeneration Switch and warning lights. The DPF will trap soot from the engine exhaust gases. The SCR uses Diesel Exhaust Fluid to reduce the levels of NOx in the engine exhaust. The ATS will periodically clean (regenerate) the DPF.

Aftertreatment System Detail

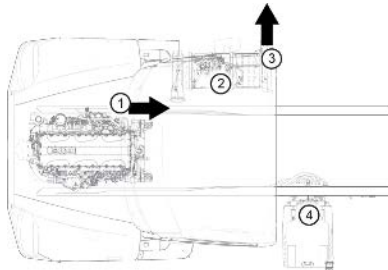

1. Hydrocarbon Doser from Turbo

2. Aftertreatment Unit (DPF, DEF Doser and SCR)
3. Filtered/Treated Exhaust
4. Diesel Exhaust Fluid (DEF) Tank

Lamps

Aftertreatment System Warning Lamps

ATS specific warning lamps and indicator symbols are located on the main gauge cluster.

Diesel Particulate Filter (DPF) Warning Lamp

This warning symbol will appear when the DPF needs to be regenerated and then also during the regeneration cycle. This icon may also appear if the system is attempting to automatically regenerate while the vehicle is in Power Take Off operation mode.

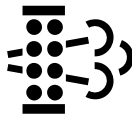

Engine aftertreatment system includes a diesel particulate filter and DPF warning lamp.

Diesel Exhaust Fluid (DEF) Lamp

Engine aftertreatment system includes a diesel exhaust fluid (DEF) warning lamp on the DEF gauge and additional warning lamps in the instrument cluster.

DEF Warning Lamp in Instrument Cluster



Diesel Exhaust Fluid (DEF) Gauge

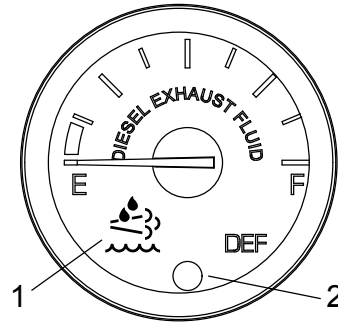

1. DEF Symbol
2. DEF Gauge Warning Lamp

The DEF lamp(s) will illuminate when the fluid in the DEF tank reaches a low level. If the lamp illuminates but the level is full, seek service immediately for DEF fluid quality or DEF equipment repair.

High Exhaust System Temperature (HEST) Warning Lamp

Engine aftertreatment system includes a high exhaust system temperature (HEST) warning lamp.



Keep vehicle a safe distance from combustible items.



WARNING

Temperature of the tail pipe, exhaust pipe, the diesel particulate filter (DPF) / selective catalytic reduction (SCR) device and surrounding components including enclosures and steps, will be

elevated during and shortly after a regeneration event or normal vehicle operation when engine is under high or heavy loading.

If the High Exhaust System Temperature (HEST) warning lamp is on:

- Do not park in an area of combustible vapors or materials. You must keep combustibles at least 1.5 m (5 ft) away from the exhaust (outlet) stream (as it exits the tail pipe) while the HEST lamp is illuminated. Always park your vehicle outside. Failure to do so could ignite an explosion or harm bystanders which could result in serious injury.
- Do not park in an area where people are close by. You must keep combustibles at least 1.5 m (5 ft) away from the exhaust outlet while the HEST lamp is illuminated. Failure to do so could result in serious injury.
- Do not approach the exhaust system or surrounding areas without allowing adequate time for the system to cool down. Failure to

do so could result in serious burns to the skin.

Malfunction Indicator Lamp

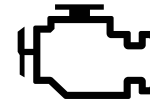

Illuminates when an engine emissions failure has occurred. The vehicle can be safely driven but should be serviced to correct the problem. The situation should not be considered an emergency. In some cases, the Malfunction Indicator Lamp (MIL) will activate in conjunction with the High Exhaust System Temperature (HEST), Diesel Particulate Filter (DPF) and Diesel Exhaust Fluid (DEF) warning lamps.



NOTE

The malfunction indicator lamp (MIL) will illuminate if the on-board diagnostics (OBD) system detects a possible emissions system failure. The vehicle should be brought in for service at the next opportunity to ensure the condition is corrected.

Emissions System Lamp

Perform the following steps if an emissions related derate occurs and the emissions lamp comes on.



1. Add DEF fluid (more than 1/4 tank).
2. Perform parked regeneration.
3. Seek service at the next stop if the warning light is still on.

Stop Engine Lamp

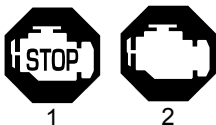

The stop engine warning lamp will illuminate, and an audible tone will sound, when a major engine problem exists. Your vehicle will be equipped with one of the indicators above, 1 or 2, depending on the engine model.



WARNING

If the Stop Engine warning lamp illuminates, it means you have a serious engine system problem. This should be considered an emergency. You should stop the vehicle as safely as possible and turn OFF the ignition. The vehicle must be serviced and the problem corrected before driving again. Failure to comply may result in death, personal injury, equipment or property damage.

For engines with the engine-protection shutdown feature enabled, the stop engine lamp will begin to flash 30 seconds before the engine automatically shuts down. The warning lamp alerts the operator to the impending shutdown.

The lamp will also illuminate when the DEF tank is almost empty or the soot level in the DPF is at full capacity. At this level warning, regeneration cannot be performed and engine power will be derated.

Engine may automatically shut down if the check engine lamp and stop engine lamp are illuminated and the operator does not correct the condition.

What is a Diesel Particulate Filter?

The diesel particulate filter is a component of the overall vehicle emission system that traps particulate matter, soot, from the exhaust. Soot is composed of the partially burned particles of fuel that occur during normal engine operation (black smoke).

Functionality / Notification Information

The ATS will regenerate the DPF by using hot exhaust gases normally generated by the engine. This typically occurs during highway operation (known as "Passive" Regeneration) and is transparent to the operation of the vehicle.

Occasionally, the exhaust gases are not hot enough for Passive Regeneration. When this occurs, the ATS will regenerate the DPF by increasing the exhaust temperature. This is referred to as an "Automatic" Regeneration and is also transparent to vehicle operation. An Automatic Regeneration event typically

lasts 30 minutes. During and shortly after the event, the exhaust gases from the DPF may reach temperatures in excess of 650° C (1202° F). See the information in the following table on probable causes and recommended actions related to the warning lamps and indicator symbols of the ATS.

The ATS may not be able to regenerate the DPF when the vehicle is driven at extended low speeds or with frequent starts and stops. In such cases, warning lamps and indicator symbols will alert the operator to take action. The operator should be aware of whether the lamps are on unaccompanied or in combination with others. The following table will describe each warning lamp(s) and what actions are needed from the operator.

Related concepts

Extended Idling









Idling the engine for 3 or more hours in freezing temperatures accelerates the build up of soot in the DPF. The system will illuminate the DPF warning light on the instrument cluster to indicate that the DPF requires regeneration. If the DPF Lamp turns on, follow the instructions described under [How to Enable an Automatic Regeneration of the DPF](#) on page 21.

 CAUTION
<p>If you ignore the warning lamp and do not initiate regeneration at the soonest, safest possible time, the DPF will become increasingly clogged with soot and can lead to severe engine derate. Failure to comply may result in equipment or property damage.</p>

Extended idling may also increase hydrocarbon deposits and moisture in the DPF. The engine will increase RPM

automatically, regardless if the DPF lamp is on or off, to remove these hydrocarbon deposits and moisture. The engine speed will remain elevated for 20 to 60 minutes. If necessary, the RPMs can be lowered by depressing the throttle, clutch, or brake pedal. The system will restart this cycle with high idle until all of the deposits are removed from the DPF. If the vehicle cannot perform an automatic cycle, the driver will be prompted with a message to Regenerate the DPF. If the levels of hydrocarbon deposits and moisture continue to build up, the system will illuminate the DPF Lamp along with the Stop Engine Lamp.

Warning Symbols Quick Reference



FOR INFORMATION		SEEK SERVICE		TAKE IMMEDIATE ACTION	
	Hot Exhaust - Stay Clear		Check Engine	 Coolant Temperature	Stop vehicle and idle engine.
	Regenerate DPF		Engine - Emissions	 Engine Oil Pressure	Stop the engine or the engine may automatically shutdown. ¹
	See <i>Diesel Exhaust Fluid (DEF) Lamp</i> on page 12.		See <i>Emissions System Lamp</i> on page 14.	 Stop Engine Symbols ²	
Any of the above icons may appear alone or together to alert of necessary action to be taken as soon as possible. Warnings may be either tell-tales or lights within the gauge associated with that fluid. These lights will start flashing to notify of the upcoming engine derate.					

¹ May not apply for fire or emergency vehicle applications.

² Either symbol 1 or 2 will appear depending on engine make for the vehicle.



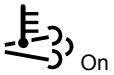





Notification of High Exhaust System Temperature

These conditions will result in the High Exhaust System Temperature (HEST) indicator turning on.

Warning Indicator	Condition	Operator Actions
	<p>Any one or combination of these conditions:</p> <ul style="list-style-type: none"> • Exhaust outlet temperature is elevated above normal (at least 450° C / 842° F) and vehicle slows below 8 kph / 5 mph. • Normal driving but engine is under heavy loading. • Automatic Regeneration in process • Parked Regeneration in process 	<p>Follow all warnings listed below. Use the STOP or DISABLE function of the Regeneration Switch (Or turn the ignition off) if the situation requires. Follow the instructions described under Stop an Automatic or Parked Regeneration.</p>
<p> WARNING</p>		
<p>Temperature of the tail pipe, exhaust pipe, the diesel particular filter (DPF) / selective catalytic reduction (SCR) device and surrounding components including enclosures and steps, will be elevated during and shortly after a regeneration event or normal vehicle operation when engine is under high or heavy loading.</p>		

2

Notification Regeneration is Required

Level	Warning Indicators	Condition	Operator Actions
1	 On	The soot level in the DPF is above the desired level and requires regeneration.	How to Enable an Automatic Regeneration of the DPF on page 21
2	 Flashing	The soot level in the DPF continues to stay above the desired level and requires regeneration.	Regenerate the DPF as soon as safely possible. How to Enable an Automatic Regeneration of the DPF on page 21 or How to Start a Parked Regeneration on page 22
3	 Flashing  On	The soot level in the DPF continues to stay above the desired level and requires regeneration. The engine power will derate.	Regenerate the DPF immediately. How to Enable an Automatic Regeneration of the DPF on page 21 or How to Start a Parked Regeneration on page 22
4	 Flashing (MX engine only)  On (MX engine only)  1  2 Stop Engine Lamp On – Dash chime	The soot level in the DPF is now at full capacity. Engine power derates (decrease rate depends on engine make).	At this point, you CANNOT regenerate the DPF. Tow your vehicle to an Authorized PACCAR Dealer to have the DPF removed. They will either have to clean it or replace it.

**CAUTION**

The engine derate sequence is engine specific; therefore, to learn how this system works on your vehicle, refer to the Engine Manufacturer's Operation and Maintenance Manual supplied with your vehicle. Failure to comply may result in equipment or property damage.

**WARNING**

If the Stop Engine warning lamp illuminates, it means you have a serious engine system problem. This should be considered an emergency. You should stop the vehicle as safely as possible and turn OFF the ignition. The vehicle must be serviced and the problem corrected before driving again. Failure to comply may result in death, personal injury, equipment or property damage.

Controlling Regeneration Process

Regeneration Switches

The following information explains how to control the regeneration process and use the regeneration switch.

Your vehicle may be equipped with either a two or three position Regeneration Switch, mounted on the dash.

If equipped with a two-position Regeneration Switch, the driver can initiate a Parked Regeneration when certain operating conditions are suitable for regeneration; however, you will NOT be able to Stop a regeneration if the ATS has initiated one automatically. A vehicle with a two-position DPF switch can stop a regeneration by turning the vehicle ignition **OFF**.

If your vehicle is equipped with a three-position Regeneration Switch, the driver can control the regeneration process via the **START** or **STOP** positions of the switch. The **STOP** position should be used when certain operating conditions are not suitable for regeneration.

**WARNING**

If you operate in environments that contain explosive vapors or flammable materials, look to see if your vehicle's Regeneration Switch is equipped with a **STOP** function. The **STOP** function must be activated prior to entering the above environment(s) to prevent automatic engine regeneration from occurring, which could cause an explosion or fire. Failing to activate the **STOP** function before entering a combustible environment may cause an explosion or fire that could lead to death, personal injury, equipment or property damage.



WARNING

Avoid operating the vehicle inside a building or in environments that contain explosive vapors or flammable materials if your vehicle does NOT have a **STOP** or **DISABLE** regeneration switch. In an event where the regeneration needs to be stopped, turn the vehicle ignition OFF and the system will temporarily stop the regeneration cycle. Failing to stop a regeneration cycle before entering a combustible environment may cause an explosion or fire that could lead to death, personal injury, equipment or property damage.



CAUTION

Do not leave the switch in the STOP position unless you need to cancel or stop a regeneration. Running the engine with the switch in the STOP position will result in increased soot levels in the DPF and could eventually cause the engine to derate.



NOTE

To obtain a Regeneration Switch with a STOP function, contact an authorized PACCAR dealer to obtain the proper switch and reprogramming of your engine's ECU.



NOTE

Parked regeneration requires that your vehicle is stopped with the parking brake set. See Parked Regeneration for details.

**Two-Position Regeneration Switch
Start Regeneration**

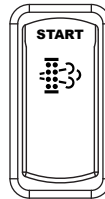

Depressing the button in the START direction for at least 4 -8 seconds will initiate a Parked Regeneration. Vehicles with this button must turn off the ignition to stop an automatic regeneration.

Related concepts

Three-Position Regeneration Switch



NOTE

The information in this section only applies to vehicles equipped with a three-position Engine Regeneration Switch.

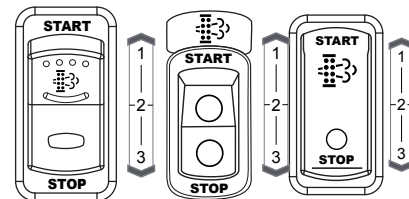

1. Start
2. Center

3. Stop

See DPF Regeneration for instructions on how to start or stop a ATS regeneration (three-position switch only).

START (Three Position Switch Only)

Depressing the button in the **START** direction (1) for at least 4 -8 seconds will initiate a Parked Regeneration.

	NOTE
Parked regeneration requires that your vehicle is stopped with the parking brake set. See Parked Regeneration for details.	

CENTER (Three Position Switch Only)

	NOTE
During normal vehicle driving, the Regeneration Switch must be in the CENTER position.	

This is the normal position of the switch. Unless you are manually initiating a Parked Regeneration or intentionally stopping a regeneration, the switch should be in this

position. Placing the switch in the **CENTER** position will allow an Automatic Regeneration to occur if conditions allow.

STOP

(Three Position Switch Only)

When **STOP** (3) is pressed, the system will not regenerate under any conditions.

	CAUTION
Do not leave the switch in the STOP position unless you need to cancel or stop a regeneration. Running the engine with the switch in the STOP position will result in increased soot levels in the DPF and could eventually cause the engine to derate.	

Related concepts

How to Enable an Automatic Regeneration of the DPF

Carefully read the following instructions to regenerate the DPF. If you have any

problems or difficulties contact your nearest authorized PACCAR dealer for assistance. Make sure that any two or three position switches for the DPF are not in a position that will prevent a regeneration from happening.

The instrument cluster will illuminate various icons that indicate a regeneration is needed. See [Notification Regeneration is Required](#) on page 18. The ATS requires conditions typically found in highway driving to regenerate the DPF. If the DPF warning lamp is illuminated, the easiest option is to assist the ATS by proceeding to the nearest highway.

1. Select a highway that has a posted legal speed of more than 35 mph (56 kph).
2. Drive your vehicle until the DPF lamp goes off. This may take 30 – 45 minutes of speeds greater than 25 mph (40 kph).

If your operation or planned route in the immediate future limits your ability to reach highway speeds, proceed to the next section titled Parked Regeneration.

2

Related concepts

How to Start a Parked Regeneration

In very limited applications or operations the DPF must be regenerated by initiating a Parked Regeneration. Follow these steps to initiate a Parked Regeneration:

1. Pull the vehicle over to a safe location.
2. Ensure no one is in the immediate vicinity of the tail pipe.
3. Maintain a minimum of 1.5 m (5 ft) of clearance to any combustible materials from the edge and top of the vehicle.



WARNING

Parking the vehicle too close to any combustible materials or vapors may start a fire, ignite an explosion or burn someone standing close by. Before pushing the Regeneration Switch on the dash, walk around your vehicle and ensure you have at least 1.5 m (5

ft) clearance from the sides and top of your vehicle to any combustibles. Ensure no one is in the immediate vicinity of the tail pipe. Failure to comply could ignite a fire or cause an explosion, resulting in death, personal injury, equipment or property damage.



WARNING

Never initiate a regeneration in a closed building or enclosure. Always park your vehicle outside and ensure no one is in the immediate vicinity. Failure to comply could ignite a fire or cause an explosion, resulting in death, personal injury, equipment or property damage.



NOTE

Typical operation areas or materials that can contain explosive vapors, flammable materials or people in close proximity of the vehicle are:

- Fuel depots
- Grain elevators
- Dry grass, leaves or trees

- Transfer refuse stations/ dumps
- Parking lots
- Load/unload terminals

While the list above may appear comprehensive, it is your responsibility to take the necessary precautions and be aware of your surroundings and ensure that no combustibles (materials or vapors) or bystanders are close by before initiating a regeneration.

4. Verify that the following conditions are met before proceeding. A Parked Regeneration will not initiate if any of these conditions are not met:
 - Parking brake is applied / set
 - Engine is at low idle
 - DPF warning lamp is illuminated or flashing
 - Coolant is at operating temperature
 - No throttle, brake or clutch applied
 - PTO is disengaged ³
 - Transmission is in neutral
 - Cruise control switch is off
 - Engine brake switch is off

5. Get out and walk all around vehicle to ensure that the vehicle is at least 1.5 m (5 ft) away from all combustible materials and no one is in the immediate vicinity.
6. Climb back into the vehicle.
7. Push the regeneration button at least 4 -8 seconds to initiate a Parked Regeneration.

Regeneration will automatically shut off if any of the conditions (in step 4) change or become activated. Contact your nearest PACCAR dealer for assistance if you are unable to initiate a Parked Regeneration and the DPF warning lamp is illuminated.

Related concepts

Stop an Automatic or Parked Regeneration

Always stop or prevent the vehicle from performing an automatic or parked regeneration ANYTIME you plan to drive your vehicle into a building, enclosure or sensitive area. Turn the vehicle ignition off to stop and prevent the DPF from regenerating. Alternatively, if the vehicle has a DPF switch to **DISABLE** or **STOP** a regeneration, depress this switch to prevent or stop a regeneration. Turn the vehicle ignition OFF if the regeneration switch does not stop or the vehicle does not have a switch that can stop a regeneration.

	NOTE
Acknowledgment that a Parked Regeneration has initiated will vary by engine. The most predominant acknowledgment to you will be an increase in engine rpm and overall engine noise.	

	NOTE
A Parked Regeneration may take 30 or more seconds to initiate as the Aftertreatment System conducts various self-checks to verify all the system requirements have been met.	

	WARNING
Never allow an Automatic Regeneration to automatically start while inside a building such as a service bay, shop or building of any kind. Anytime you are parking your vehicle inside a building or enclosure, ALWAYS press the Regeneration STOP or DISABLE Switch prior to entering the building. Failure to comply could ignite a fire or cause an explosion, resulting in death, personal injury, equipment or property damage.	

	WARNING
Never initiate a regeneration in a closed building or enclosure. Always park your vehicle outside and ensure no one is in the immediate vicinity. Failure to comply could ignite a fire or cause an explosion, resulting in death, personal injury, equipment or property damage.	

³ Parked regeneration with PTO engaged is dependant on vehicle configuration.



WARNING

If you operate in environments that contain explosive vapors or flammable materials, look to see if your vehicle's Regeneration Switch is equipped with a **STOP** function. The **STOP** function must be activated prior to entering the above environment(s) to prevent automatic engine regeneration from occurring, which could cause an explosion or fire. Failing to activate the **STOP** function before entering a combustible environment may cause an explosion or fire that could lead to death, personal injury, equipment or property damage.



WARNING

Avoid operating the vehicle inside a building or in environments that contain explosive vapors or flammable materials if your vehicle does NOT have a **STOP** or **DISABLE** regeneration switch. In an event where the regeneration needs to be stopped, turn the vehicle ignition OFF and the sys-

tem will temporarily stop the regeneration cycle. Failing to stop a regeneration cycle before entering a combustible environment may cause an explosion or fire that could lead to death, personal injury, equipment or property damage.



NOTE

To obtain a Regeneration Switch with a STOP function, contact an authorized PACCAR dealer to obtain the proper switch and reprogramming of your engine's ECU.

What is a Selective Catalyst Reduction System?

The SCR system reduces Nitrogen Oxides (NOx) from the exhaust by mixing Diesel Exhaust Fluid (DEF) with a catalyst. The DEF is contained in a separate tank on the vehicle and the level of fluid in the tank is shown in a gauge on the dash.

DEF is consumable and needs to be replenished, so monitor the DEF level gauge as you would the fuel level gauge.

DEF Gauge

The SCR system reduces Nitrogen Oxides (NOx) from the exhaust by mixing Diesel Exhaust Fluid (DEF) with a catalyst. The DEF is contained in a separate tank on the vehicle and the level of fluid in the tank is shown in a gauge on the dash.

Diesel Exhaust Fluid (DEF) Gauge

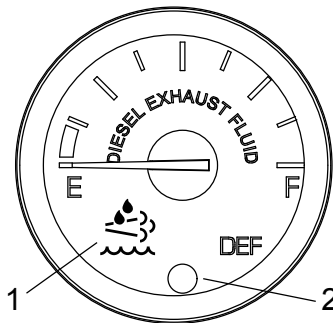

1. DEF Symbol
2. DEF Gauge Warning Lamp

DEF is consumable and needs to be replenished, so monitor the DEF level gauge as you would the fuel level gauge.

Why is the DEF Warning Light on?

There is a warning lamp located in the DEF gauge. There may also be additional warning lamps and information that will appear in the instrument cluster. These warning lamps will illuminate for the following reasons:

DEF Level The amount of DEF available in the tank is low. The warning lamp will turn on when the gauge needle is near or in the red zone. There are 4 stages to this warning.

	CAUTION
<p>If the DEF warning lamp turns on due to the DEF level, refill the DEF tank. Failure to refill may cause the engine to derate and limit vehicle speed.</p>	

DEF Quality The engine detects that DEF quality is below acceptable levels. The gauge needle is in the upper region, indicating there is fluid, but the quality is poor. There are 3 stages to these warnings.

	CAUTION
<p>See your authorized PACCAR dealer if the DEF warning lamp turns on due to DEF Quality.</p>	

<p>Failure to correct may cause the engine to derate and limit vehicle speed.</p>

SCR Component Failure

The system detects failures that may be the result of tampering with the aftertreatment (DPF/SCR) system. The gauge needle is in the upper region, indicating there is fluid, but system failure is detected. There are 3 stages to this warning.



	CAUTION
<p>If the DEF warning lamp turns on due to System Tampering, see your authorized PACCAR dealer to have this repaired. Failure to repair the system may cause the engine to derate and limit vehicle speed.</p>	





SCR System Status – Reference Chart

System Status	Non-Emergency Vehicles	Emergency Vehicles
DEF Level Warning	<i>DEF Level Warning – Non-Emergency Vehicles</i> on page 26	<i>DEF Level Warning – Emergency Vehicles</i> on page 30
DEF Quality (except PX)	<i>DEF Quality Warning – Non-Emergency Vehicles</i> on page 28	<i>DEF Quality Warning – Emergency Vehicles</i> on page 31
SCR Component Failure	<i>SCR Component Failure Warning – Non-Emergency Vehicles</i> on page 29	<i>SCR Component Failure Warning – Emergency Vehicles</i> on page 32
	<div style="border: 1px solid black; padding: 5px;"> <p data-bbox="613 519 667 568" style="text-align: center;">i</p> <p data-bbox="675 536 745 559">NOTE</p> <p data-bbox="610 589 1414 663">The malfunction indicator lamp (MIL) will illuminate if the on-board diagnostics (OBD) system detects a possible emissions system failure. The vehicle should be brought in for service at the next opportunity to ensure the condition is corrected.</p> </div>	

Functionality / Notification Information





DEF Level Warning – Non-Emergency Vehicles







Level	Warnings \ Indicators		Condition	Effect on Engine
0	None		DEF level sufficient	None
1	DEF warning lamp On		DEF level fallen below initial warning	None
2	DEF warning lamp flashing		DEF level fallen below initial warning	None
3	DEF warning lamp flashing	 Check engine lamp On	DEF level fallen below initial warning	Engine power derated 25%
4	DEF warning lamp flashing	 Check engine lamp On	DEF level empty	Continue to 40% engine power derate

Level	Warnings \ Indicators			Condition	Effect on Engine	
Final	DEF warning lamp flashing	 Check engine lamp On	 MIL may be On	  1 2 Stop engine lamp may be On	Engine has been shut down, idled for 1-hour or a fuel re-fill has occurred	Engine power derated and/or vehicle speed significantly limited

DEF Quality Warning – Non-Emergency Vehicles



The DEF Warning Lamp described in this table only applies to vehicles powered by PACCAR MX Engines.









Level	Warnings \ Indicators			Condition	Effect on Engine
0	None			No DEF quality issue	None
1	DEF warning lamp On	 Check engine lamp On	 MIL may be ON	Quality issue detected	None
2	DEF warning lamp flashing	 Check engine lamp On	 MIL may be ON	80 km (50 mi) or 1 hour after detected	Engine power derated 25%

Level	Warnings \ Indicators			Condition	Effect on Engine	
3	DEF warning lamp flashing	 Check engine lamp On	 MIL may be ON		241 km (150 mi) or 3 hours after detected	Continue to 40% engine power derate
Final	DEF warning lamp flashing	 Check engine lamp On	 MIL may be ON	 1  2 Stop engine lamp may be On	Engine has been shut down, idled for 1-hour or a fuel re-fill has occurred	Engine power derated and/or vehicle speed significantly limited

SCR Component Failure Warning – Non-Emergency Vehicles





The DEF Warning Lamp described in this table only applies to vehicles powered by PACCAR MX Engines.

Level	Warnings \ Indicators			Condition	Effect on Engine	
0	None			No Issue	None	
1	DEF warning lamp On	 Check engine lamp On	 MIL may be ON		Failure detected	None

Level	Warnings \ Indicators			Condition	Effect on Engine	
2	DEF warning lamp flashing	 Check engine lamp On	 MIL may be ON		80 km (50 mi) or 1 hour after detected	Engine power derated 25%
3	DEF warning lamp flashing	 Check engine lamp On	 MIL may be ON		322 km (200 mi) or 4 hours after detected	Continue to 40% engine power derate
Final	DEF warning lamp flashing	 Check engine lamp On	 MIL may be ON	 1  2 Stop engine lamp may be On	Engine has been shut down, idled for 1-hour or a fuel re-fill has occurred	Engine power derated and/or vehicle speed reduced to 8 kph (5 mph)

DEF Level Warning – Emergency Vehicles









Level	Warnings \ Indicators		Condition	Effect on Engine
0	None		DEF level sufficient	None
1	DEF warning lamp On		DEF level fallen below initial warning	None

Level	Warnings \ Indicators			Condition	Effect on Engine	
2	DEF warning lamp flashing				DEF level fallen below critical warning	None
3	DEF warning lamp flashing	 Check engine lamp On			DEF level less than 5%	Vehicle speed limited to 88 kph (55 mph)
Final	DEF warning lamp flashing	 Check engine lamp On	 MIL may be On	 1  2 Stop engine lamp may be On	DEF Level empty and vehicle has been shut down or stationary for 1-hour	Vehicle speed limited to 40 kph (25 mph)

DEF Quality Warning – Emergency Vehicles

The DEF Warning Lamp described in this table only applies to vehicles powered by PACCAR MX Engines.









Level	Warnings \ Indicator	Condition	Effect on Engine
0	None	No DEF quality issue	None

Level	Warnings \ Indicator			Condition	Effect on Engine	
1	DEF warning lamp On	 Check engine lamp On	 MIL may be ON		Quality issue detected	None
2	DEF warning lamp flashing	 Check engine lamp On	 MIL may be ON		10-hours after detected	Vehicle speed limited to 88 kph (55 mph)
Final	DEF warning lamp flashing	 Check engine lamp On	 MIL may be ON	 1  2 Stop engine lamp may be On	20-hours after detected, engine has been shut down or idled for 1-hour	Vehicle speed limited to 40 kph (25 mph)

**SCR Component Failure Warning –
Emergency Vehicles**

The DEF Warning Lamp described in this table only applies to vehicles powered by PACCAR MX Engines.

Level	Warnings \ Indicators	Condition	Effect on Engine
0	None	No Issue	None

Level	Warnings \ Indicators			Condition	Effect on Engine	
1	DEF warning lamp On	 Check engine lamp On	 MIL may be ON		Failure detected	None
2	DEF warning lamp flashing	 Check engine lamp On	 MIL may be ON		10-hours after detected	Vehicle speed limited to 88 kph (55 mph)
Final	DEF warning lamp flashing	 Check engine lamp On	 MIL may be ON	 1  2 Stop engine lamp may be On	40-hours after detected, engine has been shut down or idled for 1-hour	Vehicle speed limited to 40 kph (25 mph).

Chapter 3 | MAINTENANCE

In this Chapter:

3

Aftertreatment System Power Requirements.....	35
Diesel Exhaust Fluid (DEF) Tank Straps.....	35

Aftertreatment System Power Requirements

The aftertreatment system uses battery power for up to 10 minutes after the ignition is turned off. After the ignition turns off, the aftertreatment system circulates DEF to help cool down the fluid and prevent overheating. For situations where the battery will be disconnected (ie for service or maintenance of the vehicle), please wait 10 minutes before disconnecting battery power.



CAUTION

Wait at least 10 minutes after the key switch is turned OFF before disconnecting battery power. The system uses battery power to circulate DEF and prevent overheating of the DEF system. Failure to comply may result in equipment or property damage.

Diesel Exhaust Fluid (DEF) Tank Straps

Maintenance checks for the DEF tank.

During normal operation of the truck, the DEF tank straps may relax. Inspect the spring on top of the strap. If more than 1/2" (12.7mm) of the spring is exposed, the bolt will need to be re-torqued between 70 – 80 in-lbs. (7.9 – 9 Nm). This distance (1) is measured from the washer at the end of the spring to the edge of the tube at the top of the straps.

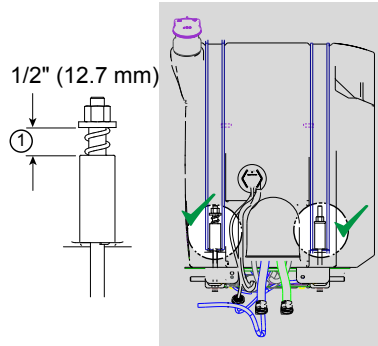

See Engine Operator's Manual for DEF filter maintenance interval.

Chapter 4 | INFORMATION

In this Chapter:

Tampering with Aftertreatment System.....	37
Diesel Particulate Filter (DPF) System.....	37
Selective Catalytic Reduction (SCR) System.....	38
Diesel Exhaust Fluid (DEF).....	38

Tampering with Aftertreatment System

The aftertreatment system for your vehicle as installed from the factory was specifically designed to meet the emissions requirements of the US Environmental Protection Agency and California Air Resources Board. Any changes of component locations or modifications of any aftertreatment system components may reduce the emission effectiveness and you may be subject to fines under the United States Clean Air Act.

Diesel Particulate Filter (DPF) System

The DPF system consists of a Hydrocarbon (HC) Doser (may not apply to all engines), a Diesel Oxidation Catalyst (DOC), and a DPF. During normal operation the DPF filters soot out of the exhaust and constantly monitors inlet and outlet pressure. When the DPF is full, the system will activate (via automatic or a parked regeneration) the HC Doser which

sprays a small amount of diesel fuel (the HC) into the exhaust stream which then reacts with the DOC to generate heat. This heat will turn the trapped soot into ash until the filter is completely cleaned (regenerated). Over time, both soot and ash accumulate in the DPF unit. While the soot is cleaned by the system, the resulting ash must be removed by servicing the vehicle at an authorized PACCAR dealer. A vehicle with a DPF has up to two additional indicator lamps on the dashboard. The two additional lamps, along with the check engine lamp, alert the operator of the status of the DPF.

 CAUTION
<p>Do not submerge or allow water to enter the DPF assembly. Components of the assembly can be damaged and affect the performance of the aftertreatment system. Failure to comply may result in equipment or property damage.</p>

 NOTE
<p>Refer to your engine manufacturer's Operator's Manual for diesel particulate filter (DPF) maintenance information.</p>

 NOTE
<p>Refer to your vehicle or engine manufacturer's Operator's Manual for additional information on the engine indicator lamps.</p>

 NOTE
<p>Ultra low sulfur diesel (ULSD) fuel is required for engines equipped with an aftertreatment diesel particulate filter. If ULSD is not used, the engine may not meet emissions regulations, and the DPF or aftertreatment Diesel Oxidation Catalyst (DOC) can be damaged.</p>

Selective Catalytic Reduction (SCR) System

The SCR system is composed of several main components:

1. Aftertreatment Control Module⁴
2. DEF Dosing Unit (DEF Module)
3. DEF Dosing Valve
4. SCR Catalyst



CAUTION

It is unlawful to tamper with, modify, or remove any component of the SCR system. Failure to comply may result in equipment or property damage.

The system uses DEF from the DEF tank and delivers it to the DEF Doser. This DEF doser sprays a small amount of DEF into the exhaust upstream of the SCR Catalyst. The DEF vaporizes and decomposes to form carbon dioxide and ammonia. The ammonia and SCR catalyst reacts with the NOx in the exhaust to break down the

Nitrogen Oxides (NOx) to form nitrogen and water.

DEF:

- may have a slight ammonia smell
- is colorless
- is non-toxic and non-polluting
- is non-flammable

Diesel Exhaust Fluid (DEF)

Diesel Exhaust Fluid Recommendations and Specifications



CAUTION

It is unlawful use Diesel Exhaust Fluid (DEF) that does not meet the specifications provided or to operate the vehicle/equipment without DEF. Failure to comply may result in equipment or property damage.



WARNING

Diesel Exhaust Fluid (DEF) contains urea. Do not get the substance in your eyes. In case of contact, immediately flush eyes with large amounts of water for a minimum of 15 minutes. DO NOT swallow internally. In the event the diesel exhaust fluid is ingested, contact a physician immediately. Reference the Materials Safety Data Sheet (MSDS) for additional information. Failure to comply may result in personal injury.



CAUTION

Never attempt to create Diesel Exhaust Fluid (DEF) by mixing agricultural grade urea with water. Agricultural grade urea does not meet the necessary specifications required and the aftertreatment system may be damaged. Failure to comply may result in equipment damage.

⁴ Only for PACCAR MX powered vehicles.

CAUTION

PACCAR Inc requires the use of DEF meeting ISO 22241-1 (DIN 70070) specifications. There is NO acceptable substitute. Failure to use the correct DEF may cause engine damage and/or void the warranty.

- Some locations may reference the DIN 70070 standard. DEF specification limits of this standard are identical to ISO 22241-1.

PACCAR Inc is not responsible for failures or damage resulting from what PACCAR Inc determines to be abuse or neglect, including but not limited to: operation without correctly specified DEF; lack of maintenance of the aftertreatment system; improper storage, or shutdown practices; unauthorized modifications of the engine and aftertreatment system. PACCAR is also not responsible for failures caused by incorrect DEF or by water, dirt or other contaminants in the DEF. Refer to your engine and vehicle operator's manuals for maintenance, storage, and shutdown information.

For engines using SCR operating in the United States and Canada, it is recommended that the DEF used be certified by the American Petroleum Institute (API).

NOTE

To ensure the correct DEF is used, PACCAR Inc recommends the use of TRP® CleanBlue Diesel Exhaust Fluid which is available in different quantity options from small to bulk containers.



DEF Availability

- DEF is readily available at truck stops and at all PACCAR Engine

dealers. For assistance locating DEF, contact your local PACCAR authorized repair location.

- If your vehicle is out of DEF and you are unable to locate a source to purchase DEF, please contact the vehicle OEM customer care center at the telephone number provided in the vehicle operator's manual. The vehicle OEM customer care center will be able to contact the nearest dealer location to you and arrange for an emergency shipment of DEF to your location 24 hours a day.

The following are other common names used for Diesel Exhaust Fluid (DEF):

- AUS 32 (Aqueous Urea Solution 32)
- AdBlue
- NOx Reduction Agent
- Catalyst Solution

Regardless of what the DEF is called, the DEF must meet the ISO 22241-1 (DIN 70070) specifications.

Related concepts

DEF Storage



NOTE

The following information is for reference and is to be used as a guideline only. There are many factors that determine Diesel Exhaust Fluid (DEF) shelf life, with temperature and duration being two of the major determining contributors. If in doubt, replace the fluid with known quality DEF. DEF has a limited shelf life, both in the vehicle's diesel exhaust fluid tank and in storage/bulk/transportation containers.

The following conditions are ideal for maintaining DEF quality and shelf life during prolonged transportation and storage:

- Storage temperature between -5°C and 25°C (23°F and 77°F)
- Storage in sealed containers to avoid contamination
- Avoidance of direct sunlight

In these conditions, Diesel Exhaust Fluid (DEF) has a minimum expected shelf life of

18 months. If stored at higher temperatures for extended periods of time, the shelf life will be reduced by approximately 6 months for every 5°C (9°F) above the highest storage temperature listed above. Long term storage in a vehicle (in excess of 6 months) is not recommended.



NOTE

To assist in preventing DEF from deteriorating when stored in the vehicle's DEF tank, locate and plug the tank's venting to seal the tank exposure to the atmosphere.

DEF Tank

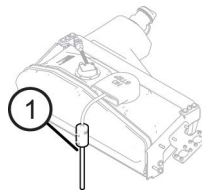

1. DEF Tank Vent

Related concepts

DEF Handling



CAUTION

If Diesel Exhaust Fluid (DEF) is spilled on metal surfaces (for example the steps, fuel tanks or grab handles) rinse and clean immediately with water. Failure to do so may leave permanent corrosive stains on the metal surfaces which can not be removed.

- Make sure to only use approved containers to transport and store DEF. Containers made of polyethylene and polypropylene are recommended.
- If DEF is spilled, rinse and clean immediately with water.
- Avoid prolonged contact with skin. In case of contact, wash immediately with soap and water. If not washed immediately, a white film will be left when the DEF dries.

	NOTE
<p>Spilled DEF, if left to dry or wiped away with a cloth only, will leave a white residue. Failure to clean the spilled DEF may result in an incorrectly diagnosed leak of the DEF Dosing system.</p>	

Before using containers, funnels, etc. that will be used to dispense, handle or store DEF, make sure to wash thoroughly to remove any contaminants and then rinse with distilled water.

	NOTE
<p>Do not use tap water to rinse components that will be used to deliver diesel exhaust fluid. Tap water will contaminate the DEF. If distilled water is not available, rinse with tap water and then rinse with DEF.</p>	

DEF Disposal

If disposing Diesel Exhaust Fluid (DEF), always check with the local authority

regulations on proper disposal process and requirements.

Related concepts

Contamination / Incorrect Fluid

The following guidelines are available if DEF gets contaminated or the level of DEF the tank is significantly different than what the gauge reads.

	CAUTION
<p>Never add water or any other fluid besides what is specified to the DEF tank. The aftertreatment system may be damaged.</p>	

The system monitors the DEF fluid quality under normal operating temperatures and when the vehicle is moving 8 kph (5 mph). In some situations, the system may not check DEF quality because of reduced operating temperatures. A service tool may be required to temporarily allow the system to check the DEF quality at operating temperatures regardless of vehicle speed. In the event that the incorrect fluid is added to the Diesel Exhaust Fluid tank, such as, but not limited to:

- Water

- Diesel Fuel
- Hydraulic Fluid
- Coolant
- Windshield Washer Fluid

Contact a local PACCAR Authorized Repair location to determine the appropriate repair direction. If only water has been added to the DEF tank, drain the DEF tank, flush with distilled water and refill with new and/or known good DEF.

Related concepts

Index

A

Aftertreatment System Warning Lamps [12](#)

C

Contamination / Incorrect Fluid [41](#)

D

DEF Handling [40](#)

DEF Level Warning – Emergency Vehicles [30](#)

DEF Level Warning – Non-Emergency Vehicles [26](#)

DEF Quality Warning – Emergency Vehicles [31](#)

DEF Quality Warning – Non-Emergency Vehicles [28](#)

DEF Storage [40](#)

Diesel Exhaust Fluid (DEF) Lamp [12](#)

Diesel Exhaust Fluid tank maintenance [35](#)

Diesel Particulate Filter (DPF) System [37](#)

Diesel Particulate Filter (DPF) Warning Lamp [12](#)

DPF Regeneration [21](#)

F

Functionality / Notification Information [14](#)

H

High Exhaust System Temperature (HEST) Warning Lamp [13](#)

I

Idling in Freezing Temperatures, Extended [15](#)

Illustrations [8](#)

Introduction [24](#)

M

Malfunction Indicator Lamp [13](#)

N

Notification of High Exhaust System Temperature [17](#)

Notification Regeneration is Required [18](#)

P

Parked Regeneration [22](#)

R

Recommendations and Specifications [38](#)

Regeneration Switches [19](#)

Regeneration SwitchTwo-Position [20](#)

Regeneration SwitchThree Position [20](#)

S

Safety [7](#)

Safety Alerts [7](#)

SCR Component Failure Warning – Emergency Vehicles [32](#)

SCR Component Failure Warning – Non-Emergency Vehicles [29](#)

Selective Catalytic Reduction (SCR) System [38](#)

Stop an Automatic or Parked Regeneration [23](#)

Stop Engine Lamp [14](#)

T

Tampering with Aftertreatment System [37](#)

W

Warning Symbols Quick Reference [15](#)

What is a Diesel Particulate Filter [14](#)

PACCAR Inc.

P.O. Box 1518

Bellevue, WA 98009

Y53-6091-1B1