

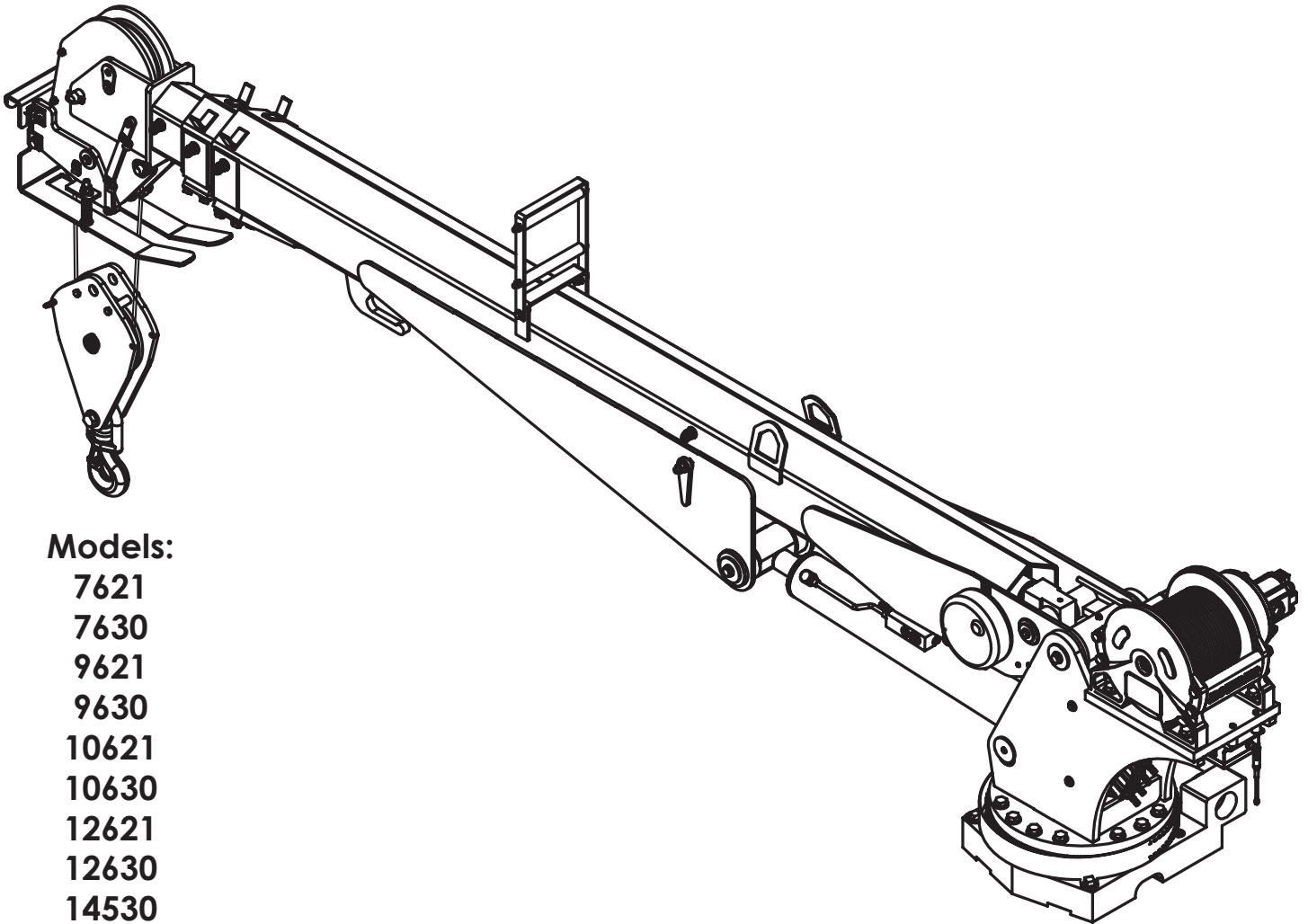

Heavy-Duty Telescopic Cranes Owner's Manual

Safety • Operation • Maintenance • Troubleshooting



Models:

7621
7630
9621
9630
10621
10630
12621
12630
14530

Notice: A copy of this manual must remain with the equipment at all times.
For a printable download copy, please visit: www.stellarindustries.com

Stellar Industries, Inc.

190 State Street

PO Box 169

Garner, IA 50438

800-321-3741

Fax: 641-923-2811

www.stellarindustries.com

Heavy-Duty Manual Revisions

Date of Revision	Section Revised	Description of Revision

For Technical Questions, Information, Parts, or Warranty, Call Toll-Free at

800-321-3741

Hours: Monday - Friday, 8:00 a.m. - 5:00 p.m. CST

Or email at the following addresses:

Technical Questions, and Information

service@stellarindustries.com

Order Parts

parts@stellarindustries.com

Warranty Information

warranty@stellarindustries.com

Table of Contents

Introduction.....	iv
Chapter 1 - Operation	1
General Operation.....	1
Pre-Operation Inspection	1
Job Site Setup	2
Step 1: Disengage drive axle and set the parking brake.....	2
Step 2: Engage the PTO.....	2
Step 3: Turn on power to the crane.....	3
Step 4: Position the stabilizers.....	3
Step 5: Operate the crane.....	4
Step 6: Stow the crane.....	6
Step 7: Stow the stabilizers.....	6
Step 8: Disengage the PTO and deactivate power.....	6
Step 9: Release the parking brake.....	7
Radio Remote Control Functions.....	7
Radio Remote Feedback and Boost Mode.....	8
Radio Remote Control Features	9
Wire Rope/Sheave Configurations.....	10
Safety Decals of Note	11
Body/Chassis.....	11
Stabilizers	11
Crane Compartment.....	12
Main Boom.....	13
Crane Horse Head	14
Valve Bank.....	14
Main Cylinder.....	14
Chapter 2 - Maintenance.....	15
General Maintenance Guidelines.....	15
Basic Crane Maintenance Schedule*	15
Hydraulic Oil/Filter Maintenance.....	16
Washing the Crane.....	16
Paint Maintenance	16
PTO and Pump Maintenance	16
Wire Rope Maintenance	16
Winch Maintenance	16
Extension Boom Maintenance.....	16
Counterbalance Valve Test Procedure	16
Rotation Gear Bearing Maintenance	17
Gear-Bearing Bolt Maintenance	18
Rotation Gear Bearing Thread Tightening Procedure	18
Rotation Gear Bearing Thread Tightening Procedure	19
Rotation Gear Bearing Tilt Test	20
Rotation Gear Bearing Worm End Play & Backlash.....	21
Face Seal/O-Ring Size Chart	22
Lubrication Recommendations	23
Chapter 3 - Troubleshooting.....	25
Stellar® CDT™ Radio Remote Troubleshooting	28
Synchronizing the Receiver and Transmitter	29
Receiver/Transmitter Identification Tag	29
Stellar® CDT Radio Error Code Troubleshooting	30
Manual Operation.....	31
Model 14530 Manual Operation	31

Introduction

Stellar® Cranes are designed to provide safe and dependable service for a variety of operations. With proper use and maintenance, these cranes will operate at peak performance for many years.

To promote this longevity, carefully study the information contained in this manual before putting the equipment into service. Though it is not intended to be a training manual for beginners, this manual should provide solid guidelines for the safe and proper usage of the crane.

Once you feel comfortable with the material contained in this manual, strive to exercise your knowledge as you safely operate and maintain the crane. This process is vital to the proper use of the unit.

A few notes on this manual:

A copy of this manual is provided with every crane and can be found in the hard plastic manual case that is installed on the chassis. A copy of this manual shall remain with the crane at all times.

Throughout the manual, three signal words will be used to bring attention to important items:

NOTICE

A NOTICE signal word indicates a practice not related to physical injury.

⚠ WARNING

A WARNING signal word indicates a hazardous situation which, if not avoided, could result in death or serious injury.

⚠ DANGER

A DANGER signal word indicates a hazardous situation which, if not avoided, will result in death or serious injury.

Information contained within this manual does not cover all maintenance, operating, or repair instructions pertinent to all possible situations. Please be aware that some sections of this manual contain information pertaining to Stellar® manufactured cranes in general and may or may not apply to your specific model.

This manual is not binding. Stellar Industries, Inc. reserves the right to change, at any time, any or all of the items, components, and parts deemed necessary for product improvement or commercial/production purposes. This right is kept with no requirement or obligation for immediate mandatory updating of this manual.

In closing:

If more information is required or technical assistance is needed, or if you feel that any part of this manual is unclear or incorrect, please contact the Stellar Customer Service Department by phone at 800-321-3741 or email at service@stellarindustries.com.

Chapter 1 - Operation

Safety should be the number one thought on every operator's mind. Three factors should exist for safe operation: a qualified operator, well-maintained equipment, and the proper use of this equipment.

This chapter contains information regarding the safety and operation of Stellar® manufactured EC Series Telescopic Cranes and should be read and understood completely by everyone working with or near the crane before putting the unit into operation.

⚠ WARNING Failure to follow operating, maintenance, or safety instructions can result in death or serious injury.

General Operation

It is the responsibility of the owner to instruct the operator in the safe operation of the equipment and to provide the operator with properly maintained equipment.

⚠ WARNING Stellar® Crane operators must conform to the qualifications specified in ANSI B30.5 - Chapter 5-3 Operation. Trainees or untrained persons shall be under the direct supervision of qualified persons.

Operators shall consult with the owner of the equipment regarding current safety regulations and required personal protective equipment.

Please take note that Stellar Industries, Inc. is not liable for accidents incurred by the crane because of non-fulfillment from the operator's side of current rules, laws, and regulations.

Pre-Operation Inspection

Before operating the equipment, make sure all regular maintenance has been performed. Each day, inspect the crane for all of the following:

- Vehicle for standard checks such as proper tire inflation and fluid levels.
- Parking brake operation.
- Hydraulic reservoir for proper oil level.
- Hoses and gearboxes for evidence of oil leaks.
- Crane controls for excessive wear, cleanliness and proper operation.
- Operational aids such as decals for placement and legibility.
- All securing hardware such as cotter pins, snap rings, hairpins, and pin keepers for proper installation.
- Crane hook and other loose parts for damage to structures or weld.
- Anti-two block switch for proper function.
- Wire rope for broken wires, extensive wear, distortion, and heat damage.
- All safety guards for proper installation.

Replace/repair as necessary prior to operation. For a more detailed checklist of scheduled inspection points, refer to the Stellar® Crane Inspection Log. This document is an essential guide for the daily, monthly, quarterly and annual inspection tasks that will help maintain the quality of your Stellar product.

Job Site Setup

Thoroughly plan the lift by understanding the work site area and your loads before positioning the vehicle. For a complete and detailed description of job site setup, please refer to the AEM Safety Manual (Form C-70-2). Consider the following:

- The vehicle should be positioned in an area free from bystanders and overhead obstructions. Use a signal person if necessary.
- **⚠ DANGER** Always maintain safe clearance from high voltage power lines in accordance with ANSI B30.5: 5-3.4.5 Operating Near Electric Power Lines. Death or serious injury will result from inadequate clearance if crane, load, or vehicle becomes electrically charged.
- Make certain that the vehicle is parked on stable, flat ground as close to the job as possible. The surface under the service truck must be able to support the weight of the machine and its load.
- Use wheel chocks if parking the vehicle on a slope.
- Always park the vehicle with the grade. If cross-grade parking is required, the load capacity must be decreased appropriately to mitigate tipping risk.
- **⚠ WARNING** Do not operate the crane during electrical storms.
- In dusty work areas, every effort must be taken to keep dust and sand out of the moving parts of the machinery.
- In high humidity work areas, keep parts as dry as possible and well lubricated.

Step 1: Disengage drive axle and set the parking brake.

The drive axle must be disengaged and the parking brake must be set before operating any of the equipment.

Step 2: Engage the PTO.

1. Make certain that the transmission is in neutral/park and that the PTO switch is in the 'off' position.
2. Start the vehicle engine.
3. Depress the clutch on manual transmission vehicles.
4. Engage the PTO. Consult the PTO manual for specific instructions if needed.
5. Slowly release the clutch on a manual transmission vehicle.
6. Allow the hydraulic system oil to warm before operating hydraulic equipment.

Step 3: Turn on power to the crane.

To initiate electrical power to the crane, activate the button labeled 'Main Power' on the VEC control panel. The VEC control panel is commonly mounted on the floor in the middle of the vehicle cab. Feel free to activate any other button functions needed for the job.

Note: For non-VEC control panels, consult the manufacturers' documentation of operation.



Step 4: Position the stabilizers.

Extend the stabilizers using the control levers or switches marked 'stabilizer' or 'outrigger'. These may be located in the compartment under the crane or on the rear bumper.

1. Locate the street side stabilizer control handle (labeled "SS"). Push the lever down to lower the stabilizer leg on the street side of the truck. While looking under the rear of the truck, you will see the street side stabilizer leg lowering to the ground. When the stabilizer makes solid contact with the ground, release the control lever.
2. Locate the extension stabilizer lever. Push the extension lever down to fully extend the curb side stabilizer.
3. Locate the curb side stabilizer control handle (labeled "CS"). Push the CS lever down to lower the stabilizer to the ground. Release the lever when the stabilizer has made solid contact with the ground.



⚠ WARNING Keep clear of stabilizer legs during operation. Moving stabilizers can cause serious crushing injuries. Make certain that all personnel are clear of the stabilizer and the ground contact point before operating.

⚠ WARNING Do not raise the rear tires of the truck off the ground with the stabilizers. Confirm that the stabilizers are positioned on stable, flat ground and that the truck is as level as possible both front to rear and side to side. Use stabilizer pads to ensure the proper distribution of weight.

Step 5: Operate the crane.

Using the Radio Remote:

To operate the crane using the radio remote control:

1. Activate and hold the desired toggle switch (See next page for details).
2. While holding the toggle, gently pull the variable speed trigger until the crane begins to move. The speed of the crane will vary in direct correlation to how much or how little the trigger is engaged.



Note: The radio remote allows for simultaneous functions. With practice, it is possible to use more than one toggle at the same time (Extension Out/Winch Down for example).

Unstowing the Crane:

To unstow the crane and prepare it for a lift:

- Winch down slightly.
- Raise the boom high enough to clear the boom rest and any other obstructions from the chassis.
- Rotate the crane until it clears the side of the truck body.
- Lower the crane boom down far enough so that the snatch block is within comfortable reach.
- Winch down to create slack in the wire rope and unhook the snatch block.

Attaching the load:

- Position the crane with the hook centered directly over the load avoid side loading.
- Attach the load to the hook by means of slings or other approved devices.

⚠ WARNING Never use a sling bar or anything larger than the hook throat that could prevent the hook latch from closing. This would negate the safety feature.

- Maintain a minimum of 3 full wraps of wire rope on the winch drum at all times.

⚠ WARNING Do not wrap the wire rope around the load.

Lifting the load:

Lift the load slightly off the ground to check the safety of the cargo. Consider the following:

- Make certain that the stabilizers are positioned on flat, stable ground.
- **⚠ WARNING** Never exceed manufacturer's load charts and ratings. These ratings are based on the machine's hydraulic, mechanical, and structural design rather than stability.
- It is the responsibility of the operator to know the weight of both the rigging and the handled load to avoid overloading the crane. Do not rely on the overload device to determine maximum rated loads. If the crane is picking more than the maximum rated load, the overload protection device may be malfunctioning. Discontinue use immediately and contact Stellar Customer Service for support.
- **⚠ WARNING** Do not use a crane to lift personnel.
- Do not attempt to lift fixed loads.

Moving the load:

Ensure that the load is secure and balanced within the sling before moving. Consider the following:

- Be sure that the crane is level and stable before moving the load.
- Always look for any changes to the surroundings since the job site setup. Be aware of any new or missed overhead obstructions (branches, power lines, etc) and bystanders. Use a signal person if necessary.
- **⚠ WARNING** Never operate the crane with personnel under any part the boom or load. Do not extend or rotate a load over anyone. Never allow personnel to place themselves under any part of the boom or load.
- **⚠ WARNING** Never leave a crane load suspended or unattended.
- Do not use the boom or the winch to drag a load.
- Do not use the crane boom to push downward onto anything.
- Avoid sudden starts and stops when moving a load.
- Do not drag loads with the crane.

Step 6: Stow the crane.

Once you have performed your lift and are ready to shut down the work site:

- Retract all extensions.
- Winch up to bring the snatch block within 3 feet of the boom tip.
- Lower the crane boom down far enough so that the snatch block is within comfortable reach.
- Hook the snatch block to the stow hook on the main boom. Maintain control to avoid personal injury or damage to any equipment.

⚠ WARNING

Never use the stow hook for anything other than stowing the snatch block.

- Tighten the winch line so that the snatch block comes within a few inches of the main boom. Avoid activating the anti-two block switch when tightening slack.
- Raise the boom slightly above the boom rest.
- Rotate the boom counter-clockwise until it aligns with the boom rest.
- Lower the boom gently into the boom rest.
- Store the radio remote control, preferably in the cab of the truck.



Note: Use alignment arrows located on the crane base to properly align the boom with the boom rest.

Step 7: Stow the stabilizers.

After stowing the crane:

- Return to the stabilizer controls and pull up on the CS and SS levers and fully retract the stabilizers. Note: Both levers can be used at the same time.
- Pull up on the extension lever to fully retract and store the curb-side stabilizer.

Step 8: Disengage the PTO and deactivate power.

- Depress the clutch on manual transmission vehicles.
- Disengage the PTO. Consult the PTO manual for specific instructions if needed.
- Slowly release the clutch on a manual transmission vehicle. Note: Make sure the PTO indicator light turns off.
- Turn off all switches on the VEC control panel. Note: For non-VEC control panels, consult the manufacturers' documentation of operation.

Step 9: Release the parking brake.

The parking brake must be released before moving the truck.

⚠️ WARNING Make certain that any air tanks are completely drained before moving the truck.

Radio Remote Control Functions



- A. Optional Speed Control/Compressor Start/Stop Toggle:** Push up to start or stop the optional speed control. Push down to start or stop the compressor.
- B. E-Stop Button:** Push to immediately stop all crane functionality. Note: The E-stop button is not intended to be an on/off switch. This is also the first item to check if the crane is not responding to toggle and trigger activation. Make sure the red E-Stop button is in the up or disengaged position.
- C. Engine Start/Stop Toggle:** Push to start or stop the engine.
- D. Link/Boost Button:** Push and hold for 5 seconds to engage boost mode (See the following page for details on 'Boost Mode'). If the remote loses connection with the transmitter, use this button to reconnect.
- E. Boom Up/Down Toggle:** Push up to raise the boom. Push down to lower the boom.
- F. Extension In/Out Toggle:** Push up to extend the extension. Push down to retract the extension.
- G. Winch Up/Down Toggle:** Push up to raise the winch. Push down to lower the winch.
- H. Rotate Clockwise/Counterclockwise:** Push up to rotate the boom clockwise. Push down to rotate the boom counterclockwise.

Radio Remote Feedback and Boost Mode

CDT Remote Feedback

If the crane starts to approach full capacity or an overload situation, the Stellar CDT sensory feedback system will respond:

0-79% Capacity

LEDs: Green Steady

Vibration: None

System Function: Normal

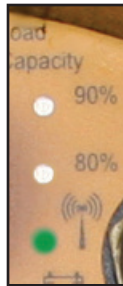

80-89% Capacity

LEDs: Green Steady, Yellow Flashing

Vibration: Short Pulsing

System Function: Normal



90-99% Capacity

LEDs: Green Steady, Yellow and Red Flashing

Vibration: Long Pulsing

System Function: Normal



100% Capacity

LEDs: Green Steady, Yellow and Red Alternate Flashing

Vibration:

Long Pulsing

System Function:

Overload Shutdown.



When the crane reaches 100% capacity, an overload shutdown will be initiated. The operator will need to set the load down and reposition the truck or activate the Stellar CDT Boost Mode (If equipped).

Activating Boost Mode (If applicable)

Boost Mode allows the crane to operate at 118% of its rated capacity for 30 seconds. This will give the operator adequate time to move the crane out of the shutdown condition without having to set the load down and reposition the truck.

Follow the steps below to activate boost mode:

1. Press and hold the Link/Boost Button for 5 seconds. This button is located on the right side of the handheld controller. You will know that boost mode is activated by an indicator light located near the boost/link button.
2. The crane will go from the 'standard mode' to 'boost mode' for 30 seconds.
3. During this minute, the capacity of the crane is increased to 118% of standard capacity.

Note: Boost Mode can be reset multiple times after a 15 second delay.

See the troubleshooting section of this manual for information regarding troubleshooting the Stellar® CDT Remote System.

NOTICE

If the 118% capacity boost is not enough to temporarily suspend the overload shutdown, the operator will need to set the load down and reposition the truck.

Radio Remote Control Features

Radio Remote Sleep Mode

The radio remote control enters sleep mode after about 15 seconds of inactivity. Activate a toggle switch to re-link the transmitter to the receiver. After re-linking, activate the desired toggle to continue operation.

E-Stop Button

The Radio remote control is equipped with an emergency stop button. If a situation arises that requires the immediate stoppage of crane functionality, press down on the red Emergency Stop button located in the center of the remote control.

NOTICE

The E-stop button is not intended to be an on/off switch. This is also the first item to check if the crane is not responding to toggle and trigger activation. Make sure the red E-Stop button is in the up or disengaged position.

Radio Remote Battery Replacement

Occasionally the batteries in the handheld transmitter will need to be changed. The AA Alkaline batteries are located in the handle portion of the radio transmitter. Release the button and slide the battery holder out. Replace the batteries and return the holder back into the handheld transmitter until the button latches.



Radio Remote Backup Cord

If the handheld transmitter has a system problem that makes the radio function un-usable, use of the back-up cord may be necessary.



DANGER

Death or serious injury will result from touching tethered remote if the crane, load, or vehicle becomes electrically charged. Always maintain safe clearance from high voltage power sources.

1. Locate the backup control cord. Most likely it is in the crane compartment, or in the cab behind the seat.

2. Remove the battery holder from the remote handle and place the similar looking end of the back-up cord in the bottom of the transmitter handle.



3. Attach the other end of the back-up cord to the connector currently used by the antenna on the control receiver. The control receiver is located on the back of the crane mast.



Wire Rope/Sheave Configurations

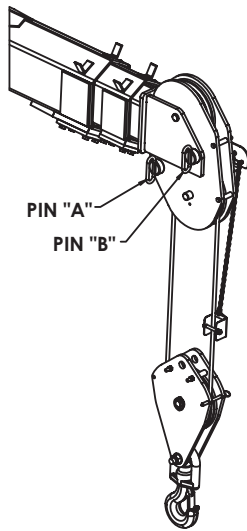

**Standard 2-Part Line
Sheave Flipped Down**
Capacities as shown on load chart.

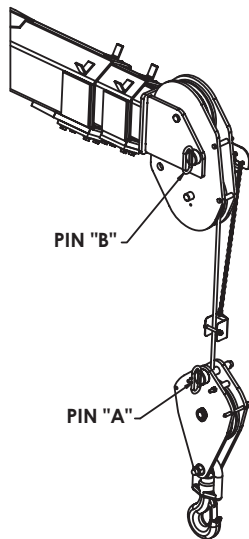

**Single Part Line
Sheave Flipped Down**

- 1) Remove PIN "A" from boom tip.
- 2) Route wire rope through snatch block.
- 3) Pin wire rope to snatch block as shown with PIN "A"

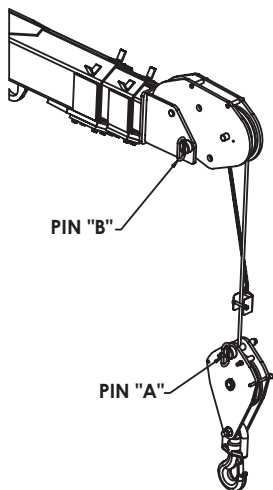

**Single Part Line
Sheave Flipped Up**

- 1) Remove PIN "B".
- 2) Flip sheave.
- 3) Insert PIN "B" with sheave in upright position.

Safety Decals of Note

Safety decals serve to inform the viewer of the hazard type, how to avoid the hazard, and the consequences of not avoiding the hazard.

Decals are considered safety equipment. They must be maintained, as would other safety devices. All safety instruction plates, notices, load charts and any other decal applied to the crane or service body must be kept legible and in good condition. Replace any decals that are missing, damaged, or illegible.

Detailed below are a number of key safety decals related to this equipment. Use the decal placement drawing in the Installation, Assembly Drawings, and Parts Manual to note the actual location of the safety decals on the equipment.

Body/Chassis

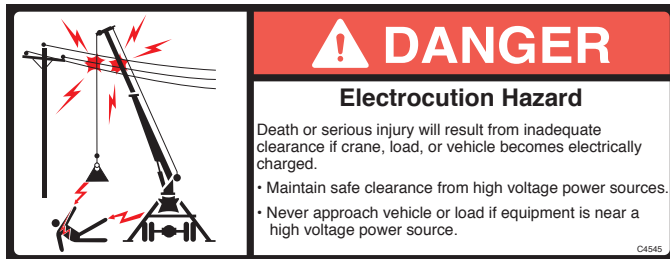

Decal Part Number: C4545

Decal Location: Four corners of the body/chassis

Hazard Type: Electrocution Hazard

Consequences: Will result in death or serious injury.

Avoidance: Maintain safe clearance from high voltage power sources. Never approach vehicle or load if equipment is near a high voltage power source.

Stabilizers



Decal Part Number: C4795

Decal Location: Each stabilizer leg

Hazard Type: Crush Hazard

Consequences: Can result in death or serious injury.

Avoidance: Keep clear of stabilizer legs during operation.

Crane Compartment

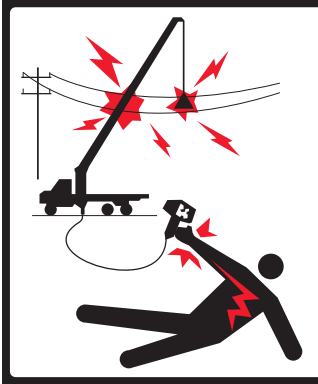

! DANGER

Electrocution Hazard

Death or serious injury will result from touching tethered remote if crane, load, or vehicle becomes electrically charged. Maintain safe clearance from high voltage power sources.

4186

Decal Part Number: 4186

Decal Location: Crane Compartment

Hazard Type: Electrocution Hazard

Consequences: Will result in death or serious injury.

Avoidance: Maintain safe clearance from high voltage power sources.

! WARNING

Overload Hazard

Do not exceed equipment load charts and ratings.

Failure to follow equipment load charts and ratings can result in death or serious injury.

4189

Decal Part Number: 4189

Decal Location: Crane Compartment

Hazard Type: Movement Hazard

Consequences: Can result in death or serious injury.

Avoidance: Do not exceed equipment load charts and ratings.

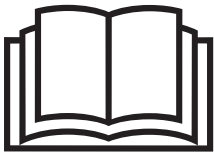

! WARNING

Untrained Operator Hazard

Read and understand all manuals and safety signs before operating or servicing this equipment.

Failure to follow operating, maintenance, or safety instructions can result in death or serious injury.

68024



Decal Part Number: 68024

Decal Location: Crane Compartment

Hazard Type: Untrained Operator Hazard

Consequences: Can result in death or serious injury.

Avoidance: Read and understand all manuals and safety signs before operating or servicing equipment.

Main Boom

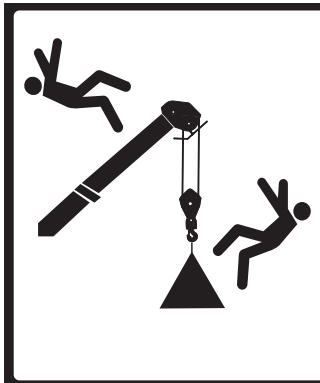

! WARNING

Fall Hazard

Hoisting personnel on boom, hook, load, or loadline can result in death or serious injury.

- Never use crane to hoist personnel.
- Never ride the boom, hook, load, or any device attached to crane boom or load line.

12451

Decal Part Number: 12451

Decal Location: Main Boom

Hazard Type: Fall Hazard

Consequences: Can result in death or serious injury.

Avoidance: Never use the crane to hoist personnel. Never ride the boom, hook, load, or any device attached to the crane boom or load line.

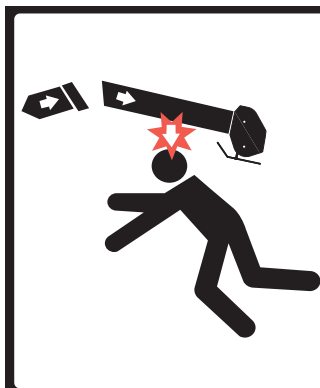

! WARNING

Free Falling Boom Hazard

Free falling manual boom extensions can result in death or serious injury.

- Properly install retention pins prior to operation.
- Do not stand in front of extension when removing retention pin.
- Do not allow extensions to free fall.

12452

Decal Part Number: 12452

Decal Location: Main Boom

Hazard Type: Free Falling Boom Hazard

Consequences: Can result in death or serious injury.

Avoidance: Properly install retention pins prior to operation. Do not stand in front of extension when removing retention pin. Do not allow extensions to free fall.

! WARNING

Misuse Hazard

Do not use stow hook for any lifting applications.

Using the stow hook for anything other than hook stowage can result in death or serious injury.

24712

Decal Part Number: 24712

Decal Location: Main Boom

Hazard Type: Misuse Hazard

Consequences: Can result in death or serious injury.

Avoidance: Do not use stow hook for any lifting applications.

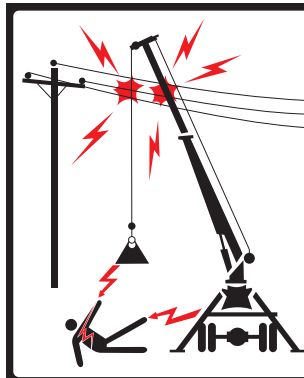

! DANGER

Electrocution Hazard

Death or serious injury will result from inadequate clearance if crane, load, or vehicle becomes electrically charged.

- Maintain safe clearance from high voltage power sources.
- Never approach vehicle or load if equipment is near a high voltage power source.

C1179

Decal Part Number: C1179

Decal Location: Main Boom

Hazard Type: Electrocution Hazard

Consequences: Will result in death or serious injury.

Avoidance: Maintain safe clearance from high voltage power sources. Never approach vehicle or load if equipment is near a high voltage power source.

Crane Horse Head

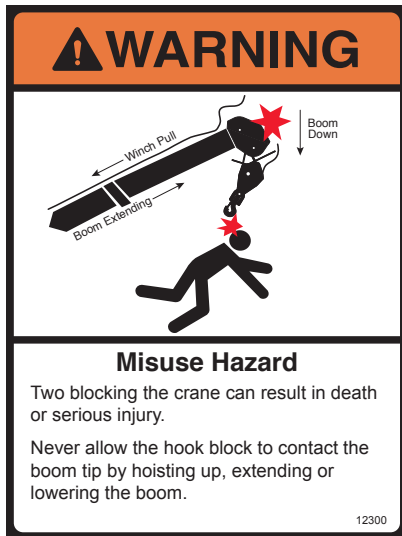

Decal Part Number: 12300
Decal Location: Crane Horse Head
Hazard Type: Misuse Hazard
Consequences: Can result in death or serious injury.
Avoidance: Never allow the hook block to contact the boom tip by hoisting up, extending or lowering the boom.

Valve Bank

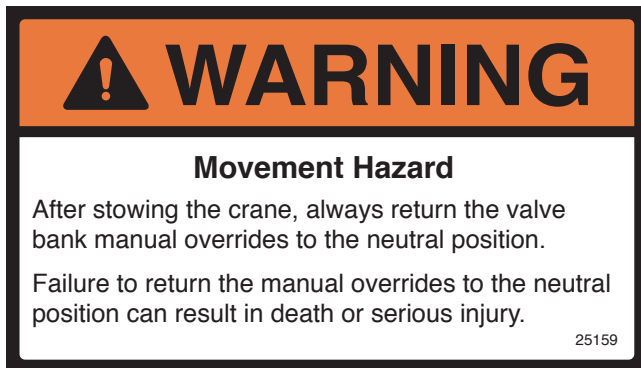

Decal Part Number: 25159
Decal Location: Valve Bank
Hazard Type: Movement Hazard
Consequences: Can result in death or serious injury.
Avoidance: After stowing the crane, always return the valve bank manual overrides to the neutral position.

Main Cylinder

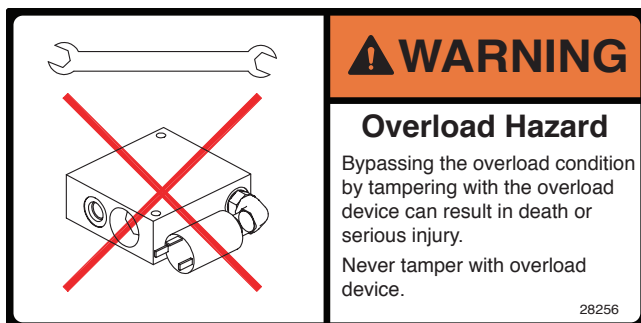

Decal Part Number: 28256
Decal Location: Main Cylinder
Hazard Type: Overload Hazard
Consequences: Can result in death or serious injury.
Avoidance: Never tamper with the overload device.

Chapter 2 - Maintenance

Maintenance is an important part of extending the life of any Stellar® Telescopic Crane. Performing key maintenance items on a scheduled program will prevent unnecessary downtime.

General Maintenance Guidelines

Before performing any maintenance to the crane, consider the following:

- **⚠️ WARNING** Only qualified service personnel are to perform maintenance on the crane. Never modify or alter any of the equipment, whether mechanical, electrical, or hydraulic, without explicit approval from Stellar Industries.
- Position the crane where it will be out of the way of other operations or vehicles in the area.
- Lower the boom fully or stow in the cradle to prevent uncontrolled movement.
- Place all controls in the off position and secure operating features from inadvertent motion. Follow all company directed lockout/tagout procedures.
- Before any service or repair is performed, disengage the hydraulic power source and shut off the engine.
- Allow systems to cool before performing any maintenance.
- Before performing any maintenance on electrical components, disconnect the power source.
- Before performing any maintenance on hydraulic components, relieve hydraulic oil pressure from all hydraulic circuits. Move pedals and control levers repeatedly through their operating positions to relieve all pressures.
- **⚠️ WARNING** Do not disconnect hydraulic hoses while there is still pressure in those components.
- Replace parts with Stellar® approved parts only.
- Keep the crane and service body clean and free from grease build-up, oil and dirt to prevent slippery conditions.
- Label or tag parts when disassembling.
- Immediately repair or have repaired any components found to be inadequate.

Basic Crane Maintenance Schedule*

Maintenance Operation	Daily	Weekly	Monthly	Hourly
Check hydraulic reservoir oil level.	X			
Grease rotation gear inner race bearings.		X		
Grease rotation gear worm drive bearings.			3 months	
Grease rotation gear open gear teeth.			X	
Grease all cylinder pivot points.			X	
Lubricate extension booms.			X	
Check winch gear grease level.			X	
Drain and replace hydraulic oil.				6500
Tighten all hydraulic lines.			6 months	

* For a more detailed outline of scheduled inspection points, refer to the Stellar® Crane Inspection Log. The Stellar® Crane Inspection Log is an essential guide for the daily, monthly, quarterly and annual inspection tasks that will help maintain the quality of your Stellar product.

Hydraulic Oil/Filter Maintenance

Stellar Industries recommends the first filter change to occur after the first 250 hours of service. The second, and every subsequent change, should occur after every 1,000 hours of service. By following these guidelines, the hydraulic oil should last up to 6,500 hours.

Note: These recommendations are based on normal working parameters. If operating in less than favorable conditions (excessive dust, moisture, etc.), be sure to check the filter gauge often for filter change notice.

Washing the Crane

Important: Prior to washing the Stellar crane, all electrical components must be covered to prevent any water from being injected into the plastic housing. Avoid any direct water pressure to any of the electrical components.

Paint Maintenance

Touch up any chips or scratches to prevent further paint damage.

PTO and Pump Maintenance

Every six (6) months, remove the hydraulic pump from the PTO and lubricate the splines using Stellar PN 20885. Failure to lubricate shaft splines will cause damage to the PTO and Hydraulic pump.

Wire Rope Maintenance

Proper maintenance is key in ensuring a long lasting rope. Refer to ANSI B30.5 for details on maintaining your wire rope.

Winch Maintenance

Refer to winch manual supplied with crane.

Extension Boom Maintenance

While operating the crane, extend and retract the extension booms. If the extension weldments are noisy during operation, it is necessary to lubricate the booms. Stellar® Model Cranes feature a metal coating which will require an aerosol lubricant. Stellar Industries recommends aerosol style lubricant Stellar PN 44512.

Counterbalance Valve Test Procedure

Extend a load to 100 percent of crane's rated capacity at an approximately horizontal boom angle. Make a temporary mark on the main cylinder rod for reference. Verify that the rod does not retract more than 1/8th inch over a 15 minute period while holding the load. If it does, the counterbalance valve may need service or replacement.

Rotation Gear Bearing Maintenance



Rotation Worm Gear and Open Gear Teeth

Use a heavy Moly Lube grease (Stellar PN 4460) to lubricate the worm gear and open gear teeth of the rotation bearing. Slowly rotate the crane while pumping the grease between the worm and rotation gear. This should be greased every month or sooner depending on the usage of the crane. Another way of applying the grease would be to remove the gear guard and brush the Molube grease between the gear teeth of the rotation bearing.

NOTICE

Do not lubricate the worm and rotation gear teeth with EP2 grease. EP2 grease will wipe the Molube grease clean causing excessive wear.

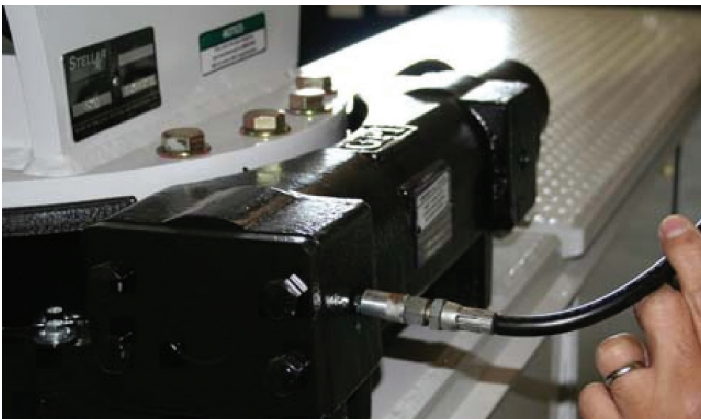

Worm Gear Bearings and Races

Apply three (3) pumps of EP2 grease to the two grease zerks located on the side of the Rotation Gear bearing; every three months. After adding the EP2 grease, rotate the crane fully.



Inner Gear Bearing Race

To lubricate the inner race of the large rotation gear bearing, open the compartment door just below the crane. The grease zerk for the inner race bearing is located on the compartment drip tray. The inner race will need to be lubricated with EP2 Grease weekly. The first week grease the inner race bearing at the one (1), three (3), five (5), seven (7), nine (9), and eleven (11) o'clock positions. The following week, grease the inner race bearing in the two (2), four (4), six (6), eight (8), ten (10) and twelve (12) o'clock positions. Rotate lubrication points every week.

Gear-Bearing Bolt Maintenance

Once a bolt has been torqued to 75% of its proof load and then removed, the torque coefficient may no longer be the same as when the bolt was new thus giving indeterminate damp loads after torquing.

⚠ WARNING Anytime a gear-bearing bolt is removed, it must be replaced with a new bolt of the identical grade and size.

NOTICE Always use Red Loctite Threadlocker sealant to secure the new bolt.

Rotation Gear Bearing Thread Tightening Procedure

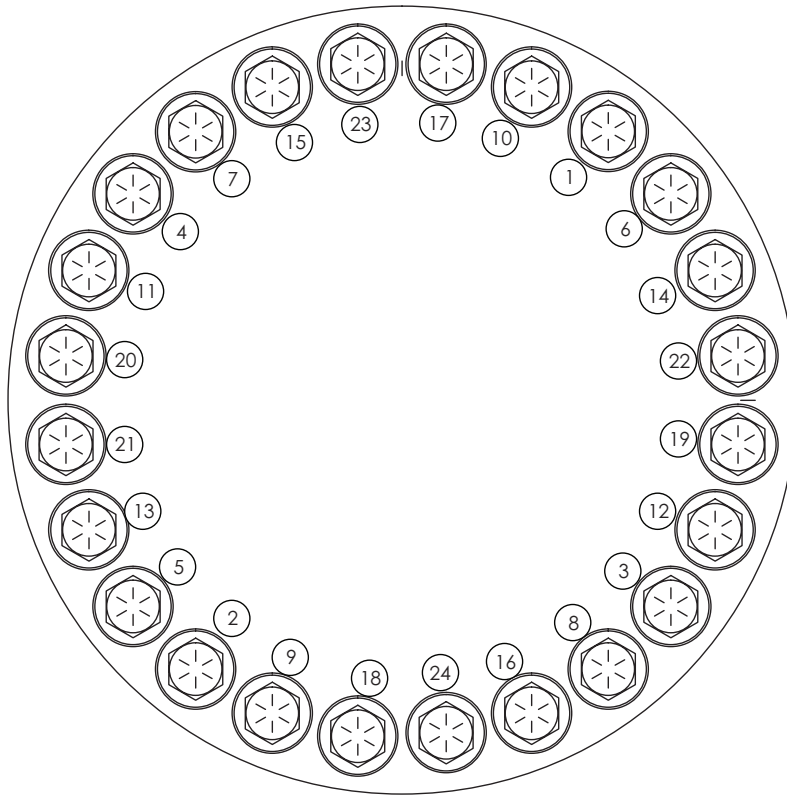

Step 1: Refer to the Torque Data Chart on the previous page to determine the proper torque value based on the size of bolt used.

Step 2: Torque all bolts to approximately 40% of the specified torque value using the tightening sequence shown above. Note: The number of bolts may be different than shown in the diagram but the sequence will work using the same pattern in relation to Bolt #1.

Step 3: Torque all bolts to 75% of the specified torque value using the tightening sequence shown above.

Step 4: Torque all bolts to the listed torque value using the tightening sequence shown above.

Rotation Gear Bearing Thread Tightening Procedure

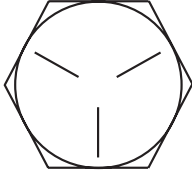
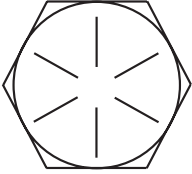
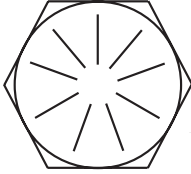
		GRADE 5		GRADE 8		GRADE 9
						
Size (DIA-TPI)	Bolt DIA (Inches)	Plain (Ft-Lb)	Plated (Ft-Lb)	Plain (Ft-Lb)	Plated (Ft-Lb)	Plated (Ft-Lb)
5/16-18	0.3125	17	13	25	18	22
3/8-16	0.3750	31	23	44	33	39
7/16-14	0.4375	49	37	70	52	63
1/2-13	0.5000	75	57	105	80	96
9/16-12	0.5625	110	82	155	115	139
5/8-11	0.6250	150	115	220	160	192
3/4-10	0.7500	265	200	375	280	340
7/8-9	0.8750	395	295	605	455	549
1-8	1.000	590	445	910	680	823
1 1/8-7	1.1250	795	595	1290	965	1167
1 1/4-7	1.2500	1120	840	1815	1360	1646
1 3/8-6	1.3750	1470	1100	2380	1780	2158
1 1/2-6	1.500	1950	1460	3160	2370	2865

When using the torque data in the chart, the following rules should be observed:

- Bolt manufacturer's particular specifications should be consulted when provided.
- Flat washers of equal strength must be used.
- All torque measurements are given in foot-pounds. To convert to inch-pounds, multiply by 12.
- Torque values specified are for bolts with residual oils or no special lubricants applied. If special lubricants of high stress ability, such as Never-Seez compound graphite and oil, molybdenum disulphite, colloidal copper or white lead are applied, multiply the torque values in the charts by the factor .90. The use of Loctite does not affect the torque values listed above.
- Torque values for socket-head capscrews are the same as for Grade 8 capscrews.

Rotation Gear Bearing Tilt Test

Step 1: Place crane in vertical position.

Step 2: Place a dial indicator on the pinion cover plate at the back side of the mast.

Step 3: Set the dial indicator to 0.

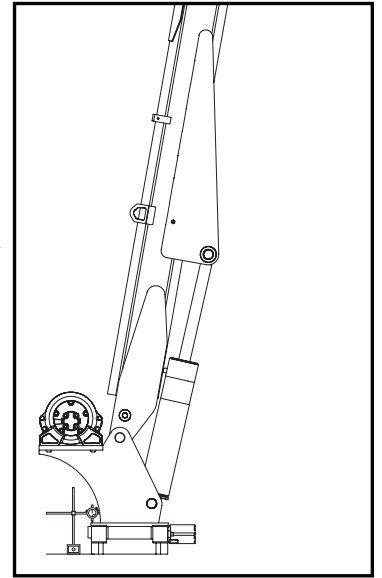

Step 4: Lower the crane to the horizontal position.

Step 5: Check and record the dial indicator change. It should not exceed the following tilt measurements:

- Stellar Models 7621 - 12630 = 0.060" (1.524 mm)
- Stellar Model 14530 = 0.070" (1.778 mm)

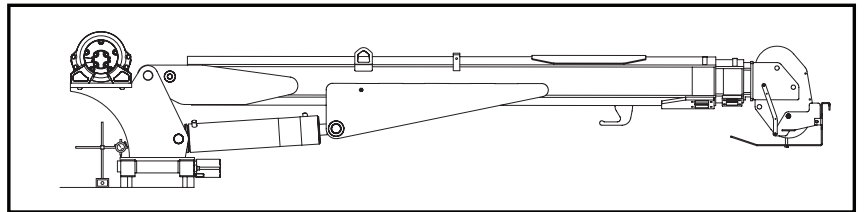

Step 6: Return the crane to vertical position. The dial indicator should return to calibration.

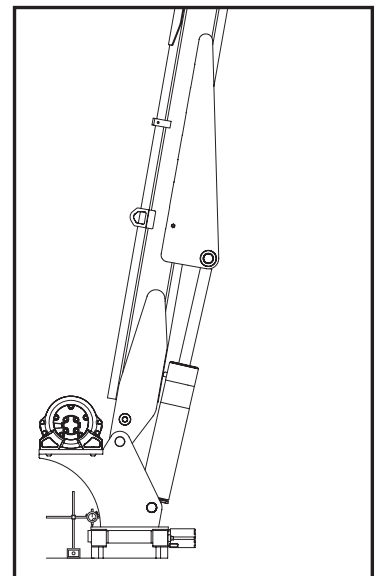

Rotation Gear Bearing Worm End Play & Backlash

Stellar® Telescopic Cranes have an integral base and worm drive rotation system.

Backlash is the shortest distance between non-driving tooth surfaces in mating gears. Measure backlash using a feeler gauge at or near the pitch diameter and tangent to the gear.

Locate High Tooth

To set both Worm End Play and Backlash, first locate the high tooth on the gear. This spot is marked by the manufacturer with light blue paint. If the paint mark cannot be found, use a dial indicator with a magnetic base and a round steel pin large enough to contact the bearing near the pitch line of the bearing tooth to locate the high tooth:

Step 1: Set the indicator base on the face of the bearing race with no teeth.

Step 2: Place the pin between two of the teeth.

Step 3: Set the indicator probe on the pin and adjust the dial to zero.

Step 4: Rotate the bearing, checking every third tooth until you find the highest indicator reading.

Step 5: Check three teeth in both directions in this area to determine the highest tooth. The amount of run-out varies depending on the diameter of the bearing.

Step 6: Once you find the high tooth, mark it for future reference.

Set Worm End Play

Step 1: Locate the high tooth on the gear (See above)

Step 2: Screw a bolt into the threaded hole nearest the high tooth. Screw additional bolts into threaded holes at 90° from the high tooth.

Step 3: Mount a magnetic base with an indicator attached on top of the worm housing and at the opposite end from the motor mount.

Step 4: Adjust the indicator to read from the end of the worm shaft. Set the indicator to 0.

Step 5: Using two of the bolts as handles, rotate the outer race back and forth. Read the total indicator movement. This measurement is the end play of the worm. The specification for end play is +0.000/-0.004" (+0.000/-0.1016mm). If end play does not meet this specification, remove the bearing retainer and add or remove shims from the unit. Repeat this procedure until the end play meets specification.

Set Gear Bearing Backlash

Step 1: Locate the high tooth on the gear (See above)

Step 2: Rotate the bearing until the high tooth is engaged with the worm. Loosen the three bearing retaining allen head bolts just enough to be able to move the bearing toward or away from the worm. Screw a bolt into the threaded hole in the bearing nearest the worm.

Step 3: Set the magnetic indicator base on the worm housing with the indicator probe against the bolt. Set the indicator dial to zero.

Step 4: Move the bearing back and forth. Watch the indicator dial and adjust the bearing in or out of the worm until the total indicator movement is 0.005" (0.127 mm). Notice: Be sure to deduct any end play in the worm from the indicator reading.

Step 5: Rotate the bearing 180°. Recheck the backlash. The total backlash should be 0.005" to 0.012" (0.127 to 0.3048 mm).

Step 6: After setting the backlash, torque the bearing retaining allen head bolts while watching the indicator dial so the correct backlash setting is maintained. Use the Torque Data Chart and Rotation Gear Bearing Thread Tightening Procedure for specifications.

Face Seal/O-Ring Size Chart

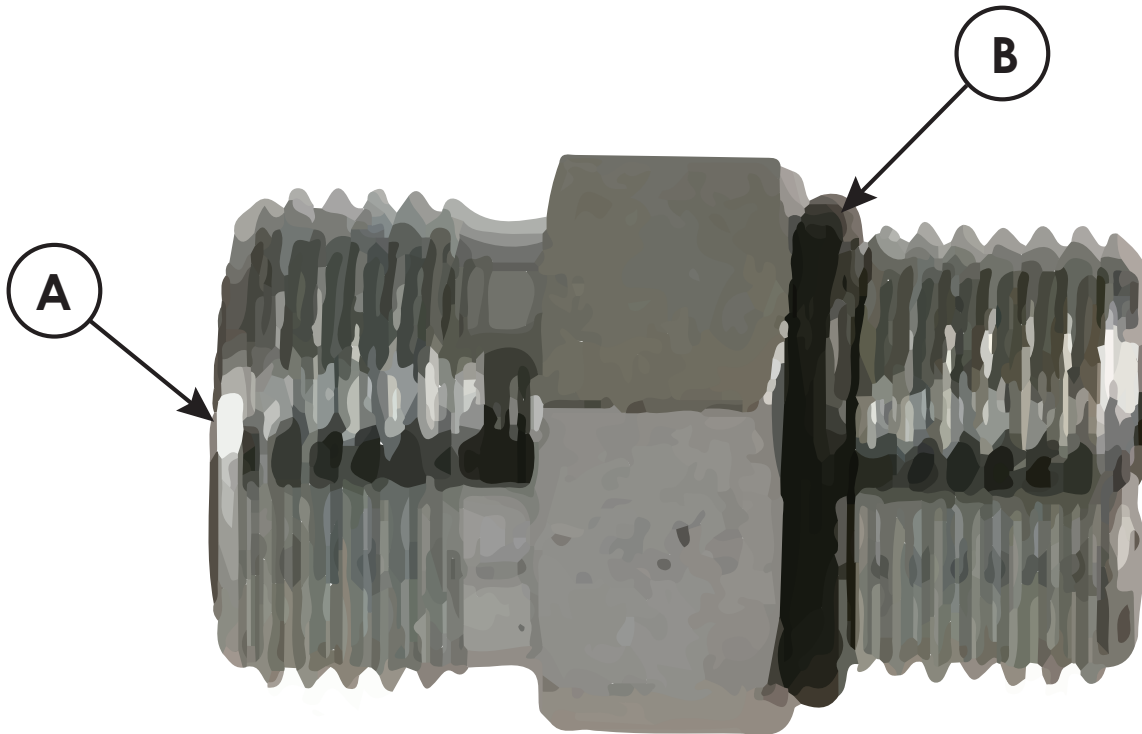

Hose Size	Fitting Size	Face Seal (A) Stellar® PN	O-ring Boss (B) Stellar® PN
1/4"	#4	C2027	D1245
3/8"	#6	C2028	D1246
1/2"	#8	C2029	D1247
5/8"	#10	32223	D1248
3/4"	#12	D1244	D1249
1"	#16		D1250

Lubrication Recommendations

Crane Lubrication

Component	Location	Recommendation
Hydraulic System	Reservoir	
	Below -5°F	High VI, low pour, ISO 22, AW hydraulic oil
	-5°F to 90°F	High VI, low pour, ISO 32, AW hydraulic oil
	Above 90°F	ISO 46, AW hydraulic oil
Open Gear Teeth	Crane Rotation Gear	Lithium complex, NLGI 2 grease with moly
Worm Drive Bearings (including turntable bearing inner race)	Crane Rotation Gear, Inside Crane Compartment	Lithium complex, synthetic based NLGI 00 grease
Cylinders	Crane Pivot Areas	Lithium complex, NLGI 2 grease
Wear Pad Lubrication	Extension Booms	Synthetic lubricant containing Teflon®

Compressor Lubrication

Component	Location	Recommendation
Reciprocating Single Stage	Compressor Crankcase	ISO 100 compressor oil
Reciprocating Double Stage	Compressor Crankcase	ISO 100 compressor oil
Screw Compressor	Compressor Crankcase	
	-15°F to 86°F	Synthetic performing ISO 32 compressor oil
	-23°F to 100°F	Synthetic performing ISO 46 compressor oil
	32°F to 113°F	Synthetic performing ISO 68 compressor oil

Greasing the Crane:
Lubricate all grease gun points with
Extreme Pressure Grease - Stellar P/N: 22059.

This page intentionally left blank.

Chapter 3 - Troubleshooting

This chapter will list a number of potential problems that may occur while operating the crane. Most problems are easily solved using the solutions portion of this chapter. If problems persist, please contact Customer Service at Stellar Industries 1-800-321-3741.

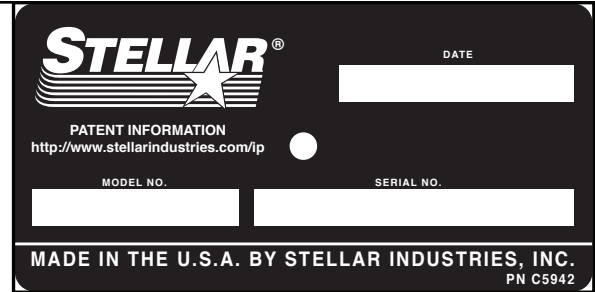

Prior to troubleshooting:

Always make sure the emergency brake is engaged, the PTO is engaged (if equipped), and the main power switch of the control panel inside the cab is turned on.

To determine if there is an electrical or hydraulic problem, first try to operate the crane manually. This is done by turning the manual override knob on the flow valve, then operating the individual solenoid valves located along the valve bank. If the crane operates, there will be an electrical problem to trace. If the crane does not operate using the manual overrides, there is a problem within the hydraulic circuit.

Problem: Crane will not operate.

Solutions:

- Make sure that the parking brake is engaged.
- Make sure that the PTO is engaged.
- Make sure that there is 12V power going to the radio receiver. If there is no power going to the receiver, trace back to the power source and check for a blown fuse or loose ground connection. Refer to radio remote troubleshooting guide at the end of this chapter.
- Make sure that the transmitter batteries are fully charged.
- Make sure that the hydraulic pump is operating at its rated flow or GPMs. Check the flow by using the flow meter to determine the GPMs. It is possible that the hydraulic pump is getting weak. If this is suspected, contact Stellar Customer Service.

Problem: Crane will operate manually but will not operate by radio remote.

Solutions:

- Make sure that there is 12V power going to the radio receiver. If there is no power going to the receiver, trace back to the power source and check for a blown fuse or loose ground connection. Refer to radio remote troubleshooting guide at the end of this chapter.
- Make sure that the parking brake is engaged.
- Make sure that the parking brake switch is working properly. Check the parking brake switch by performing a continuity test. If the switch is defective, simply replace it.

Problem: Not all crane functions operate using the radio remote transmitter or crane operates intermittently.

Solutions:

- Make sure that the toggle switch is working properly. If the switch is defective, simply replace it.
- Make sure that there is power going to the valve bank coil solenoid of the function that

will not operate. If no power is going to the coil solenoid, check wiring connections on wire harness plug connector for broken wires, loose connection or poor crimp. If power is going to the solenoid valve, it may not be opening to allow hydraulic oil to the function that is not operating. Remove stem valve, thoroughly clean, lubricate, and reinstall valve. Do not over tighten. If the valve will not close, simply replace it.

Problem: Two functions operate at the same time while only toggling one function.

Solutions:

- Make sure that the solenoid valves are all latched in the center position to ensure that they do not move while operating the crane.
- Determine the function that is operating on its own. Check to see if there is power going to the solenoid valve from a function that should not be operating. If voltage is present at the solenoid valve without operating the function, the toggle switch has failed and is stuck in the “on” function. If no voltage is present, the solenoid valve may be partially open. Remove the stem valve, thoroughly clean, lubricate, and reinstall the valve. Do not over tighten. If valve will not close, simply replace it.

Problem: Winch brake will not hold.

Solutions:

- Check to see if the back pressure on the return line of the winch is greater than 50 psi. Try operating a function other than the winch. Operate the function both ways and then stop. Now operate the winch. If the brake still does not hold, contact Customer Service at Stellar.

Problem: Winch will not hold load.

Solutions:

- Make sure that the object being lifted does not exceed the rated capacity of the winch. Refer to the capacity chart. If the object is within the rated capacity, reposition the truck and try to lift the object without using the crane boom extensions.
- Make sure that the relief valve on the winch is set correctly. Readjust the relief valve if necessary.

Problem: Crane only operates at full speed.

Solutions:

- Check to see if there is 12V power constantly going to the proportional valve. If 12 volts are showing up at the proportional valve without pulling on the transmitter trigger, the handle/trigger assembly may be defective. If 8 volts are showing at the proportional valve, it is possible that the valve is stuck open and will not close. Remove the valve, clean it thoroughly and reinstall. Do not over tighten. If the problem persists, replace the proportional valve.
- Check to see if the manual override on the proportional valve is turned out. Turn the manual override on the flow valve in.

Problem: Crane operates slowly.

Solutions:

- Make sure that the crane is receiving the recommended hydraulic flow to operate.
- Check the level of hydraulic fluid in the reservoir. Add fluid as needed.
- Check hydraulic fluid temperature.
- Check to see if the valve bank orifice is plugged. If so, replace the orifice. Call Stellar

Customer Service for instructions.

- Make sure the proportional valve is receiving 12V power when fully engaging the transmitter trigger. If there is not 12V power while pulling the trigger, check for loose connections inside the transmitter or replace the handle trigger assembly. If the proportional valve is receiving 12 volts, loosen the solenoid holding nut and check to see if the solenoid coil is magnetizing. If no polarity is present, replace the coil. If coil is magnetizing, remove the stem valve, thoroughly clean, lubricate, and reinstall the valve.

Problem: Winch “Up”, Main Cylinder “Down”, and Extension Cylinder “Out” are the only functions that don’t operate.

Solutions:

- Make sure that the anti-two block weight and chain on the end of the boom are straight so they slide easily along the wire rope cable.
- Make sure that the limit switch is working properly. Disconnect the two wires connected to the limit switch and tie them together. If all functions operate, replace the limit switch.
- Make sure that the cord for the cord reel is undamaged. Check the continuity of the cord. Disconnect the cord reel from the crane harness and bypass the harness connection. If the crane operates properly, replace cord reel.

Problem: Cylinder drifts outward or downward.

Solutions:

- Check to see if there is air in the hydraulic system. Operate all cylinders connected to the hydraulic system. Start with the extension cylinder, then operate the main boom, winch, rotation, and ending with the hydraulic stabilizers, if installed. When operating, extend each cylinder halfway out, retract all the way in, and then extend until the cylinder rod is at the end of its stroke. Operate cylinders slowly so air is pushed thru the system to the reservoir. Repeat this cycle 2-3 times.
- Make sure the holding valves are operating properly. Note: Before performing any maintenance on hydraulic components, relieve hydraulic oil pressure from all hydraulic circuits. Remove, clean, and then inspect each holding valve. When removing a holding valve, always relieve the pressure inside the cylinder by loosening jam nut of the holding valve and turning set screw inward/clockwise. Count the number of turns until the set screw is seated. When reinstalling the holding valve, make sure the valve is reset by turning the set screw the number of turns it took to relieve the pressure. Finish by tightening the jam nut.
- Check the cylinder rod for scratches. If a scratch is located on the cylinder rod, hydraulic fluid can pass thru and cause a loss of pressure. Replace cylinder rod or cylinder.
- Check to see if the piston seals are damaged. If they show signs of damage, install a new cylinder seal kit.

Stellar® CDT™ Radio Remote Troubleshooting

Note: The System Error Light can have different flash patterns. Please note these patterns to assist Stellar Customer Service when troubleshooting the radio system.

Symptom	Probable Cause	Remedy
System will not initialize after normal start-up procedure	Transmitter batteries fully discharged	Check batteries to ensure a full charge. Replace with fully charged batteries if necessary.
	No power to the receiver	Check the receiver to be sure power is applied. Ensure that the system is properly grounded.
Transmitter is transmitting (Power LED flashing), but machine will not respond Always match the receiver address and frequency channel to the transmitter.	Transmitter out of range	Take the transmitter back into the range of the receiver. Restart.
	A motion function was not in OFF position when transmitter turned on	Ensure that all switches are in OFF (neutral) position when the Start switch is activated.
	Receiver power off	Turn on power to receiver.
	Transmitter/receiver frequency channels do not match	Check frequency settings to be sure transmitter and receiver are set to same frequency channel
All machine motions operate intermittently	Receiver antenna connection is loose or missing	Tighten or replace antenna.
	Surge suppressors not installed on contactors	Install RC type surge suppressors on all magnetic contactors that are controlled by the radio remote control system
	Control wiring too close to high power machine wiring	Control wiring must be run separately from high power machine wiring.
	Another frequency may be interfering with the system.	
Some machine motions operate intermittently	Machine motion wiring may be loose.	Check wiring from receiver to plug and from plug to machine motion actuator.
	Connector inside receiver is loose	Check all connectors, reseal if necessary.
	Surge suppressors not installed on contactors	Install RC type surge suppressors on all magnetic contactors that are controlled by the radio remote control system
	Control wiring too close to high power machine wiring	Control wiring must be run separately from high power machine wiring.

Synchronizing the Receiver and Transmitter

SYNCHRONIZING THE RECEIVER AND TRANSMITTER ADDRESS AND CHANNELS

1. Press and hold the **START** switch on the transmitter while pressing and holding the **Learning Function** button on the receiver.

NOTE: The star in the Stellar logo is the **Learning Function** button.

2. Release the Start switch and Learning Function button as soon as the green RF Signal LED is flashing on the receiver.

Your receiver and transmitter are synchronized and ready to use.

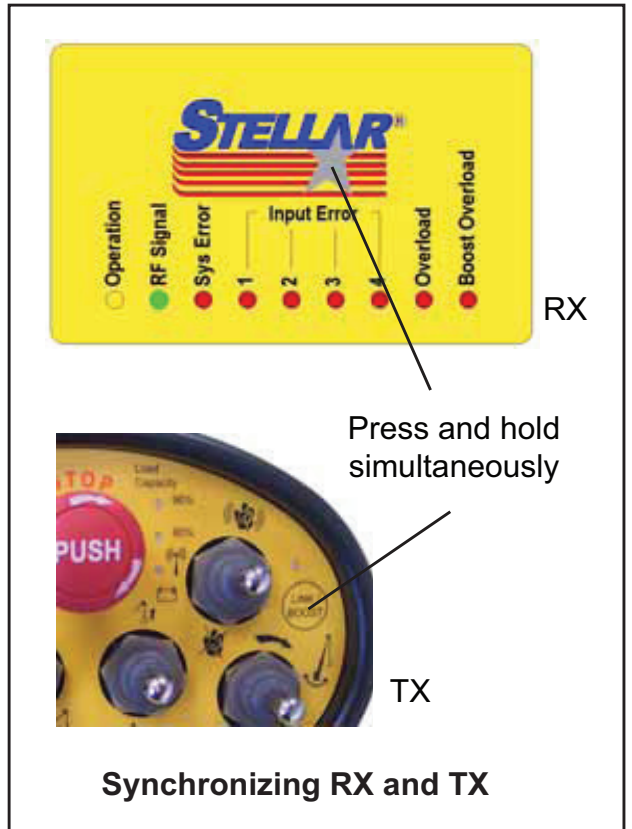

Receiver/Transmitter Identification Tag

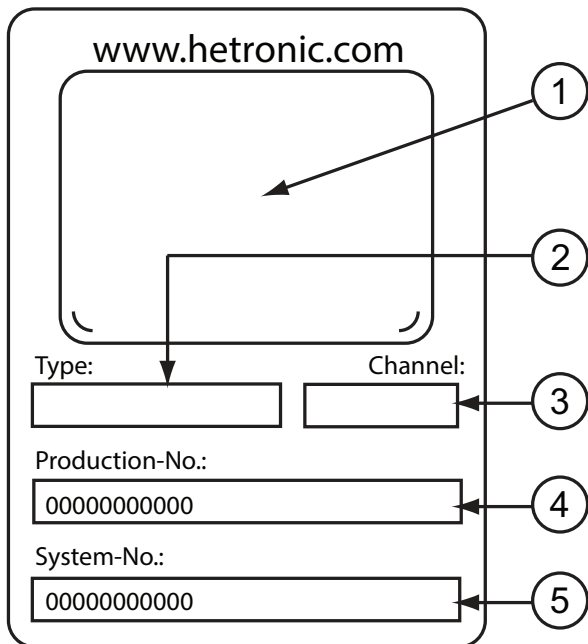

Unit Label Areas and Meanings

1. Specific approvals, such as BTZ, FCC, CE, etc.
2. Type of transmitter or receiver.
3. Frequency and RF unit.
4. Eleven-digit Production Number.
5. Eleven-digit System Number.

Stellar® CDT Radio Error Code Troubleshooting

Error Input 1 (Pressure Transducer cylinder base end) Harness wire PD1

Problem: The Boom down, Extension out, and Winch up functions do not operate and the radio receiver is displaying Input error 1.

Solutions: Check for broken or loose wires going to the transducer on the main lift cylinder. If the connector is unplugged from the transducer, plug the connector back into the transducer. If the problem still exists, check to make sure that the PD1 wire harness connector is plugged into the PD1 base end transducer. This transducer is located on the cylinder manifold assembly and is closest to the base end of the cylinder. PD2 transducer is located closest to the rod end of the cylinder. If there is no change contact Stellar Customer Service.



When troubleshooting the radio system, please note which lights are lit up on the receiver mounted on the crane. If the System Error Light (Sys Error) is flashing, please note the flash pattern. For example, Is it flashing steadily or does it have a flash pattern of 1, 2, or 3? This information may be helpful to your Stellar Customer Service Representative when diagnosing the issue with your radio system.

Problem: Winch up and Extension out do not operate while the main boom cylinder is fully retracted or the crane is stowed in the boom rest.

Solutions: Raise main lift cylinder slightly, this condition is due the safety systems of the crane.

Error Input 2 (Pressure Transducer cylinder rod end) Harness wire PD2

Problem: The Boom down, Extension out, and Winch up functions are only operating at 75% of their normal speed and the radio receiver is displaying Input error 2.

Solutions: Check for broken or loose wires going to the transducer on the main lift cylinder. If the connector is unplugged from the transducer, plug the connector back into the transducer. If the problem still exists, reverse the two transducers and see if problem reverses. If there is no change contact Stellar Customer Service.

Error Input 3 (Inclinometer)

Problem: The crane will not lift the rated load per the capacity chart and the Boom up, Extension out, and Winch up functions are only operating at 75% of their normal speed and the radio receiver is displaying Input error 3.

Solutions: Check for broken or loose wires going to the Inclinometer located just inside the main boom assembly. If the connector going to the Inclinometer has come loose or is unplugged, plug the connector back into the Inclinometer. If the problem still exists, replace the Inclinometer.

Error Input 4 (Anti-two-block)

Problem: The Boom Down, Extension out, and Winch up functions will not operate and the radio receiver is displaying Input error 4.

Solutions:

1. Make sure that the Anti-2-block weight and chain on the end of the boom are straight so it easily slides up and down the wire rope cable.
2. Make sure that the cradle bar is not bent and is not allowing the limit switch to disengage.
3. Disconnect the two wires connected to the limit switch and twist them together. If all functions operate, replace the limit switch.
4. If the functions still do not operate after testing the limit switch, visually inspect the cord reel wires going to the limit switch. If the wiring appears to be ok, check the continuity of the cord or disconnect the cord reel from the crane harness and bypass the harness connection. If the crane operates properly, replace the cord reel.

Manual Operation

If the remote control malfunctions, follow these steps to operate the crane manually:

- 1. Activate Flow Control.** Turn the override screw on proportional flow control counter-clockwise. Full adjustment is between three and five turns. Note: On 14530 models, flow control is activated by push/pull knob.
- 2. Operate Solenoids.** Using the identification decal as a guide, slide the knurled sleeve out and then push or pull to operate the desired function. Be sure the sleeve is in the center, locked, position before returning to remote operation.
- 3. Deactivate Flow Control.** Turn the override screw clockwise until stopped. Full adjustment is between 3 and 5 turns.
- 4. Return the valve bank manual overrides to the neutral position.**

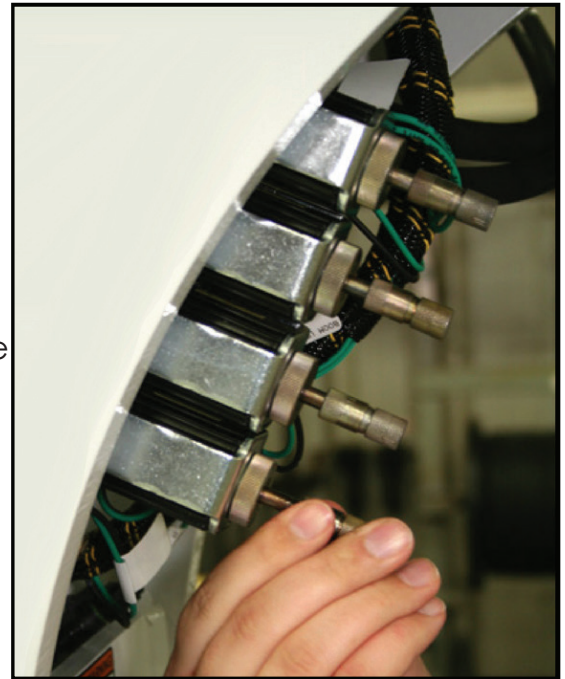

⚠ WARNING Failure to return the valve bank manual overrides to the neutral position can result in unexpected crane movement.

- 5. Have the unit serviced immediately to restore remote control functionality.**

Model 14530 Manual Operation

If the remote control malfunctions, follow these steps to operate the crane manually:

1. Activate Flow Control. Turn the override screw on proportional flow control clockwise. Full adjustment is between 1.5 and 2 turns.
2. Operate Solenoids. Using the identification decal as a guide, push the corresponding button to operate the desired function.
3. Deactivate Flow Control. Turn the override screw counter-clockwise back to its original position (between 1.5 and 2 turns).
4. Have the unit serviced immediately to restore remote control functionality.

